



Pond Kits • Spillways • Skimmers • Just-A-Falls • Filters • Basins • Statuary • Lighting



2013 POND & WATER FEATURE

CATALOG



Thank you for your interest in EasyPro. We are pleased to present you with our newest and most complete line of water feature products ever. Our entire business is water and business is good! In fact, 2012 showed significant growth and we have thousands of loyal customers to thank for that. The relaxing effect of water continues to be one of the most desired effects in landscaping.

This year marks our 43rd year in business. Our commitment to providing the industry's best selection of products combined with the best customer service has never been stronger. Recently we have added more staff, added more space and implemented a totally new computer operating system. All with the simple goal of being able to provide faster, higher levels of service to you, our valued customers!

Whether you are a new comer to water features or a seasoned veteran, we have the products and experience to help you design, build and maintain anything from small bubbling fountains to large lakes. It would be our pleasure to put 43 years of experience to work for you. Best wishes for a successful 2013!

Dave and Chris Ouwinga

Attention Pond Retailers and Contractors!

For as little as \$50 per year you can be part of this great organization who's mission is **"To promote, protect and advance the pond and waterscape industry"**. Both contractors and retailers alike benefit from being part of this organization. Some of the many benefits the IPPCA provides include:

- Offers EasyPro "Certified Aquatics Specialist" certification
- Online database for obtaining consumer leads
- Personalized web page for each certified member along with monthly newsletters
- Annual educational seminars free to members - www.INFOTANZA.com
- Mentoring program supported by top pond builders in the industry
- Industry regulatory updates and lobbying through it's legislative action team
- Professional awards, humanitarian pond builds and much, much more

To find out more about joining and supporting the IPPCA and becoming a Certified EasyPro Contractor:
Web: www.IPPCA.com • Phone: 770-592-9790 • email: info@ippca.com



By joining IPPCA contractors and retailers are supporting an association that looks to improve and grow our industry. In turn the IPPCA supports their members with certification programs, training, leads and access to other industry information. EasyPro is proud to support this organization and feels it would benefit our customers to join this organization to set themselves apart as qualified pond builders and retailers.

Lake & Pond Management Catalog



EasyPro offers a large selection of Lake & Pond management products from weed and algae controls to aeration systems to fountains. We have a separate catalog devoted solely to products and services needed to maintain larger bodies of water and Aquaculture.

Please contact us to request a copy of our Lake & Pond Management catalog today!



Please contact us via phone or website to view or request copies of our catalogs!

Praise the Lord. Give thanks to the Lord for he is good, his love endures forever. Psalm 106:1

Catalog Symbols



RETAIL FRIENDLY

Our most popular retailer/pond store items



MOTOR FREIGHT

Certain items ship motor freight only due to size or content



UPS

Handles most shipments, look for this symbol to denote any additional handling charges



MADE IN THE USA!

We are proud to produce as many items as possible in the USA



DISCOUNTS

Buy it by the case and receive discounts



ECO-FRIENDLY

Environmentally safe products, good for use with fish & plants



WEBSITE

See our website for more information and tips

Check out these new products we are introducing in 2013...



Tranquil Décor

TALL RIPPLE VASE
Part #HSV30T
Page 32



Tranquil Décor

RESIN LOG FALLS
Part #NCL21
Page 34



INTEGRA LINER

30 MIL LINER Part #PL30
Page 49



ECO-Series
WATERFALL DIFFUSER
Part #UWD46
Page 17



PUMP/FILTER/UV COMBO
Part #ESF1250
Page 78



Tranquil Décor

CRACKED VASE FOUNTAIN
Part #NC26AC
Page 34



Tranquil Décor

CLASSIC VASE FOUNTAIN
Part #HDV31BM
Page 33



BIO-BLOX IN A SMALLER SIZE
Part #BBM05
Page 76

Tranquil Décor

FOUR SIDED SQUARE VASE
Part #H4SCR
Page 31



JUST-A-FALLS KITS WITH UWD SPILLWAYS
Part #JAF24W
Page 26



Tranquil Décor

SELF CONTAINED BASIN
Part #RBC23
Page 35





Weekending (MI)

ECO-Series® Skimmers

Patented design eliminates silicone or cutting liner

- All skimmers install **inside** the liner eliminating any chance of leaks
- Strong-ribbed design holds shape perfectly and allows dirt to hold skimmer in place when backfilled
- Ideal for retail sales
- Each skimmer comes complete with molded debris basket, filter pad and lid (Tempo not sold with lid)
- Tempo skimmer is ideal for pre-formed ponds and retrofit applications!
- See page 11 for replacement parts



TEMPO SKIMMER

Industry's first "in-pond" skimmer!

- Rated for pumps up to 1800 GPH (30 GPM)
- Skimmer hangs inside pond with two straps (included)



PRELUDE SKIMMER

- Maximum flow 1800 GPH (30 GPM)
- Ideal for mag drive pumps



MELODY SKIMMER

- Maximum flow 4800 GPH (80 GPM)
- Extra strong design



OVATION SKIMMER

- Maximum flow 8100 GPH (135 GPM)
- Optional molded color lid available (see page 11)

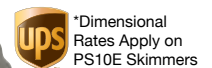

Part #	Description	Size (L x W x H)	Water Inlet	Max. Flow	Stocking Code	Ship Weight	List Price
PS3E	Tempo Skimmer	12 ¹ / ₂ " x 10 ¹ / ₂ " x 11 ¹ / ₄ "	5"	30 GPM/1800 GPH	759490	5 lbs.	\$84.99
PS4E	Prelude Skimmer	18" x 15" x 13"	5"	30 GPM/1800 GPH	3115491	12 lbs.	\$164.99
PS6E*	Melody Skimmer	21" x 22" x 21"	7"	80 GPM/4800 GPH	8206499	30 lbs.	\$294.99
PS10E*	Ovation Skimmer	21" x 22" x 27"	9"	135 GPM/8100 GPH	2234493	35 lbs.	\$334.99

Axiom Pond Skimmers

Features Include:

- Front to back design - with the pump sitting behind the debris net instead of along side it
- Adjustable overflow allows finished pond level to be adjusted
- One piece aluminum framed debris net makes cleaning quick and easy
- PSA5000 and PSA7000 come with dual 2" factory installed spinweld fittings (bulkheads) allowing for one or two pump installations
- PSA9000 and PSA11000 come with two 2" and one 3" factory installed spinwelds allowing for two smaller or one larger pump
- PSA5000/7000/9000 are compatible with the SETS2 extension tube
- The PS1UV option works with PSA5000 only
- PS1 molded faux rock lid (part #PS1LID on page 11) can be used on PSA5000/7000 skimmers

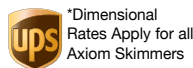

PSA5000



PSA11000



PSA11000 with two TH400 pumps



PSAFM Filter Pad Assembly

PSA11000 with TM9500 pump



Part #	Description	Size (L x W x H)	Water Inlet	Stocking Code	Ship Weight*	List Price
PSA5000	5000 GPH Axiom Skimmer	29" x 19" x 21"	6"	9282742	35 lbs.	\$434.99
PSA7000	7000 GPH Axiom Skimmer	29" x 19" x 21"	8"	1289243	35 lbs.	\$444.99
PSA9000	9000 GPH Axiom Skimmer	33" x 19" x 23"	8"	5357495	44 lbs.	\$549.99
PSA11000	11000 GPH Axiom Skimmer	33" x 19" x 23"	10"	8363994	44 lbs.	\$559.99
PSAFM	Optional Filter Pad Assembly	19 1/4" x 15 1/4" x 2"	—	646531	3 lbs.	\$71.59

Axiom Pond Skimmer/Filter Combo

Combines mechanical and biological filtration all in one

- Includes debris net and filter brushes for mechanical filtration
- A second compartment behind mechanical filtration holds UTM1 biological media, included, for complete water filtration
- Maximum flow rate 60 GPM (3600 GPH)
- Use with SETS2 extension tube (optional)

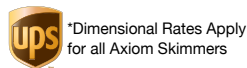
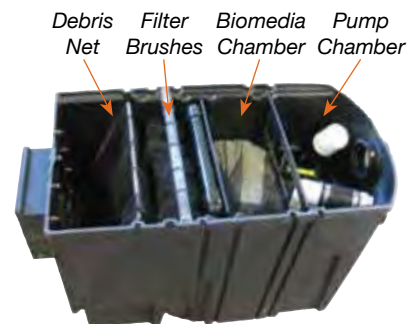

Part #	Description	Size (L x W x H)	Water Inlet	Stocking Code	Ship Weight*	List Price
PSA3600D	Pond Skimmer/Filter Combo	33" x 19" x 23"	8"	7389990	56 lbs.	\$599.99

Provides complete filtration for fish ponds up to 2000 gallons or 4000 gallon ponds without fish!



TaskMasters (MN)

Skimmer Features

- Innovative design allows you to choose between a vertical filter mat or filter brushes
- Two chamber design eliminates cutting filter pads to fit around the pump and plumbing
- Pumps can be inspected or removed without removing mesh net or filter pad
- Skimmers have a flange above the opening where water enters from the pond into the skimmer, allowing you to not only stack rocks along side but also above the skimmer opening
- Internal filters help prevent the pump from plugging and are easy to clean
- See page 11 for replacement parts



MINI SKIMMER

- Skims ponds up to 250 square feet
- Available in vertical style pad or filter brushes
- Works with small extension tube (part #SETS) - see page 7



SMALL SKIMMER

- **Our best selling skimmer!**
- Skims ponds up to 600 square feet
- Available with filter pad or filter brushes
- Works with small extension tube (part #SETS) - see page 7
- PS1FB also can be fitted with a UV (part #PS1UV) - see page 7



LARGE SKIMMER

- **One of the largest skimmers available**
- Skims ponds over 600 square feet
- PS2 skimmer is designed for high flow applications and does not have brushes or filter pad
- Works with large extension tube (part #SETL) - see page 7



Part #	Description	Size (L x W x H)	Water Inlet	Max. Flow	Stocking Code	Ship Weight	List Price
PSMFB	Mini w/filter brushes	20" x 15" x 19"	6"	50 GPM/3000 GPH	6227498	23 lbs.	\$349.99
PSM	Mini w/filter pad	20" x 15" x 19"	6"	50 GPM/3000 GPH	4233992	23 lbs.	\$359.99
PS1FB	Small w/filter brushes	28" x 18" x 20"	8"	100 GPM/6000 GPH	4318499	44 lbs.	\$489.99
PS1V	Small w/filter pad	28" x 18" x 20"	8"	100 GPM/6000 GPH	1324991	44 lbs.	\$499.99
PS2FB	Large w/filter brushes	42" x 20" x 30"	16"	300 GPM/18000 GPH	7506993	75 lbs.	\$779.99
PS2V	Large w/vertical filter	42" x 20" x 30"	16"	300 GPM/18000 GPH	8552491	75 lbs.	\$849.99
PS2	Large w/o filter pad	42" x 20" x 30"	16"	300 GPM/18000 GPH	4519995	75 lbs.	\$799.99

External Pump Skimmer

EasyPro is pleased to offer this innovative skimmer designed for use with external pumps

- Factory installed bulkhead fittings
- Pre-plumbed for easy bottom drain connection, includes plug
- Design ensures all water goes through debris net
- Uses same debris net, lid and extension tube as PSMFB skimmer
- Multiple skimmers can be plumbed to one pump, ideal for odd shaped ponds where one skimmer is not enough

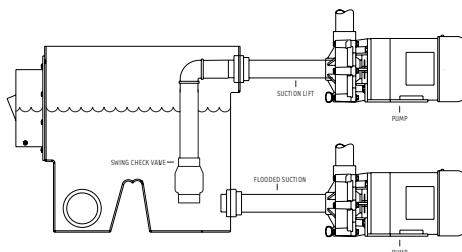

P
SERIES
O



Ideal for use with external pumps on pages 98 - 99

← 3" side inlet

← 2" pump connection



Part #	Maximum Flow	Size	Stocking Code	Ship Weight	List Price
PSMEX	4500 GPH	20" x 15" x 19"	4175493	22 lbs.	\$269.99

Skimmer Extension Tube

Makes your pond look much more natural by moving the skimmer box away from the pond

- Patented 24" long extension tube allows skimmer to be set back from the pond edge
- Allows for planting between the pond and skimmer making it easier to hide
- Can be bolted together to create longer extensions if needed
- Price includes extension tube and bolts for installation
- Ideal for use in concrete walls



Nor-Pro Landscaping (MI) used six large extension tubes to set the large skimmer on this job 12' away from the pond!

P
SERIES
O



Extension tubes make your pond look more natural!

Part #	Description	Stocking Code	Ship Weight	List Price
SETS	Fits PSM, PSMEX, PS1 skimmers	764936	9 lbs.	\$99.89
SETS2	Fits PSA3600D/5000/7000/9000 skimmers	264939	9 lbs.	\$99.89
SETL	Fits PS2 skimmers	682674	12 lbs.	\$127.19



UV Option for PS1FB & PSA5000 Skimmers

- PS1FB and PSA5000 skimmers can be outfitted with a UV Clarifier
- 36 watt bulb is enclosed inside of a divider that slips in the place of the PVC divider
- Must be used with filter brush racks not the filter pad style skimmers
- Will drop the maximum GPM flow from 100 to approximately 60 GPM to provide adequate exposure time
- Replacement UV bulbs and sleeves are available



P
SERIES
O



Part #	Description	Stocking Code	Ship Weight	List Price
PS1UV	36 watt UV upgrade for PS1 & PSA5000	3259994	8 lbs.	\$399.99
EP36B	36 watt replacement bulb for PS1UV	548612	2 lbs.	\$74.79
EP36S	36 watt replacement sleeve for PS1UV	664738	2 lbs.	\$99.59

Waterfall Filters **ECO-Series®**

These patented waterfall filter boxes are the easiest to install of any similar style filter on the market today

- Inlet bulk head fittings are pre-installed
- Biological filter media is included
- Easy, tool-free liner attachment
- An excellent choice for the “do-it-yourselfer” with an easy, user friendly installation process

See page 10 for filter lids & parts

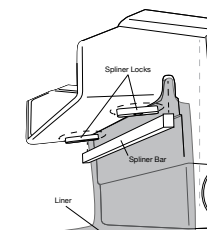

Patented “Spliner Lock” system attaches liner securely and easily - no bolts, no silicone - no puncturing the liner



PRELUDE FILTER

- Includes one filter pad and one bag of media (one cubic foot)



SONATA FILTER

- Includes two filter pads and two bags of media (two cubic feet)



MELODY FILTER

- Includes two filter pads and two bags of media (four cubic feet)



SYMPHONY FILTER

- Includes two filter pads and six bags of media (twelve cubic feet)
- Ships via freight due to size

Part #	Description	For Ponds Up To (gallons)	Size L x W x H	Waterfall Opening	Pre-Installed Water Inlet	Maximum Flow	Stocking Code	Ship Weight	List Price
WF10E*	Prelude Filter	1000	20" x 17" x 14"	13"	1 1/4"	30 GPM/1800 GPH	3108491	18 lbs.	\$154.99
WF18E*	Sonata Filter	1800	22" x 25" x 21"	18"	1 1/2"	50 GPM/3000 GPH	8209999	28 lbs.	\$299.99
WF29E*	Melody Filter	3000	24" x 25" x 24"	17"	2"	70 GPM/4200 GPH	2279993	45 lbs.	\$399.99
WF60E	Symphony Filter	6000	37" x 29" x 34"	34"	2" (dual)	150 GPM/9000 GPH	5412994	73 lbs.	\$589.99



Tempo Submersible Pond Filter

Provides mechanical and biological filtration

- Pump sits under filter pads preventing plugging
- Comes complete with dual media — white inner roll provides biological surface area while black surface media traps debris
- Ideal prefilter for small mag drive pumps

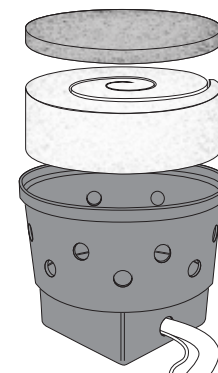

Part #	For Ponds Up To	Size	Tubing Size	Maximum Flow	Stocking Code	Ship Weight	List Price
WF6E	600 gallons	12 1/2" x 10" tall	3/4" or 1"	850 GPH	534991	3 lbs.	\$49.99

AquaFalls Biological Waterfall Filters

- AquaFalls Filters have an inlet hole on each side of the filter (except the mini AquaFalls). Use the one that's most convenient for your incoming water and simply plug the other hole with plug (included) or buy a ball valve and use the second hole as a drain
- Easy to install, simply bolt lip to filter and you're done — no foaming rock lip into place!
- AquaFalls Filters are buried into the ground making them easy to hide.

AquaFalls can be ordered with Matala Filter Pads. These are the best quality filter pads on the market. When ordered with the filter, one green and two blue pads are included. See page 77 for more information on Matala pads.

See page 10 for replacement parts

P
SERIES
O

MADE IN THE USA



MINI AQUAFALLS

- 1 1/2" inlet fitting in back of filter
- Filter comes standard with two filter pads and one large mesh bag (MB22) for filter media



SMALL AQUAFALLS

- Includes two bulkhead fittings allowing incoming water from either side
- Filter comes standard with three filter pads and two mesh bags for filter media



MEDIUM AQUAFALLS

- Includes two bulkhead fittings allowing incoming water from either side
- Filter comes standard with three filter mats and three mesh bags for filter media



LARGE AQUAFALLS

- Includes two bulkhead fittings allowing incoming water from either side
- Filter comes standard with three filter pads and six mesh bags for filter media

Part #	Description	For Ponds Up To (gallons)	Size L x W x H	Waterfall Opening	Bulkhead/ Inlet Fitting	Maximum Flow	Stocking Code	Ship Weight	List Price
AT2	Mini w/Matala Pads	1200	18" x 24" x 18"	14"	1 1/2" (1)	40 GPM	9175498	25 lbs.	\$269.99
AT	Mini Filter	1200	18" x 24" x 18"	14"	1 1/2" (1)	40 GPM	5168991	23 lbs.	\$259.99
AS2	Small w/Matala Pads	2500	26" x 26" x 26"	18"	2" (2)	70 GPM	2311996	35 lbs.	\$479.99
AS	Small Filter	2500	26" x 26" x 26"	18"	2" (2)	70 GPM	8305491	33 lbs.	\$469.99
AM2	Medium w/Matala Pads	6000	35" x 36" x 28"	26"	2" (2)	120 GPM	7438749	46 lbs.	\$674.99
AM	Medium Filter	6000	35" x 36" x 28"	26"	2" (2)	120 GPM	3428990	43 lbs.	\$659.99
AL2	Large w/Matala Pads	15000	36" x 65" x 36"	50"	3" (2)	250 GPM	1812497	75 lbs.	\$1249.99
AL	Large Filter	15000	36" x 65" x 36"	50"	3" (2)	250 GPM	3779991	73 lbs.	\$1199.99

AquaFalls Filters with Termination Strips

Above AquaFalls Filters are available with termination strips instead of faux rock lip for those who prefer to use real stone

P
SERIES
O

Part #	Description	Stocking Code	Ship Weight	List Price
AS2T*	Small w/Matala Pads & Termination Strip	3272996	34 lbs.	\$419.99
AST*	Small Filter w/Termination Strip	2266491	32 lbs.	\$409.99
AM2T	Medium w/Matala Pads & Termination Strip	8389999	45 lbs.	\$599.99
AMT	Medium Filter w/Termination Strip	7380241	42 lbs.	\$584.99
AL2T	Large w/Matala Pads & Termination Strip	1753997	73 lbs.	\$1159.99
ALT	Large Filter w/Termination Strip	3721491	71 lbs.	\$1109.99



Rock/Plant Grates for AquaFalls Filters

P
SERIES



Extra strong grate available for the small, medium and large AquaFalls

- Makes it very easy to cover the falls box with rocks and plants
- The small filter grate is an egg crate shaped material while the medium and large grates are an engineered structural plastic material

Part #	Description	Stocking Code	Ship Weight	List Price
ASGR	Small Rock Grate	334641	4 lbs.	\$53.29
AMGR	Medium Rock Grate	787094	12 lbs.	\$133.99
ALGR*	Large Rock Grate	6152687	28 lbs.	\$234.89



Waterfall Filter Replacement Parts

ECO-Series®

Part #	Description	Dimensions	Stocking Code	Ship Weight	List Price
WF10L	Prelude Filter Lid	20 ¹ / ₂ " x 17 ¹ / ₂ "	432611	7 lbs.	\$46.59
WF18L	Sonata Filter Lid	24 ³ / ₄ " x 22 ¹ / ₂ "	339121	8 lbs.	\$55.89
WF29L	Melody Filter Lid	25 ¹ / ₂ " x 24 ¹ / ₂ "	746263	7 lbs.	\$66.09
WF10P	Prelude Filter Pad, each	12" x 16"	28114	2 lbs.	\$11.59
WF18P	Sonata Filter Pad, each	18" x 14 ¹ / ₄ "	59022	3 lbs.	\$12.89
WF29P	Melody Filter Pad, each	23 ¹ / ₂ " x 20 ¹ / ₂ "	524008	5 lbs.	\$34.29
WF60P	Symphony Filter Pad, each	25" x 35"	231007	8 lbs.	\$44.29

AquaFalls Replacement Parts

P
SERIES

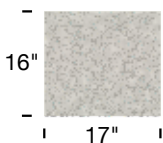

AT Pads

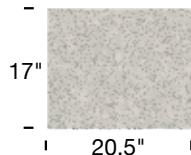

AS Pads

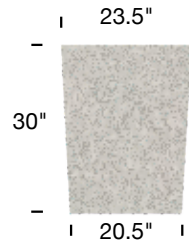

AM Pads

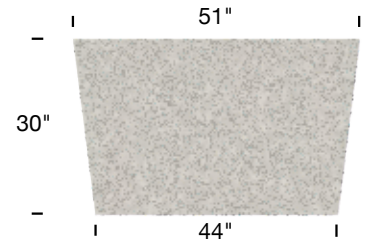

AL Pads

Part #	Description	Stocking Code	Ship Weight	List Price
AT - MINI AQUAFALLS				
ATM	Replacement Filter Pad	210781	2 lbs.	\$16.59
ATGN	Green Matala Replacement Pad	211616	2 lbs.	\$16.59
ATBE	Blue Matala Replacement Pad	211827	2 lbs.	\$16.89
ATGY	Gray Matala Replacement Pad	216865	2 lbs.	\$24.09
ATSTA	Replacement Stand Inside Filter	222613	3 lbs.	\$34.79
ATBW	Replacement Bolts & Washer Pack	24675	1 lb.	\$7.19
ATTS	Replacement Termination Strip	815790	1 lb.	\$24.29

AS - SMALL AQUAFALLS

ASM	Replacement Filter Pad	212471	2 lbs.	\$19.19
ASGN	Green Matala Replacement Pad	212806	2 lbs.	\$18.29
ASBE	Blue Matala Replacement Pad	213085	2 lbs.	\$18.69
ASGY	Gray Matala Replacement Pad	214136	2 lbs.	\$20.19
ASSTA	Replacement Stand Inside Filter	238418	3 lbs.	\$59.09
ASBW	Replacement Bolts & Washer Pack	27603	1 lb.	\$11.69
ASLIP	Replacement Waterfall Lip	254337	4 lbs.	\$83.59
ASTS	Replacement Termination Strip	318329	2 lbs.	\$28.19

Part #	Description	Stocking Code	Ship Weight	List Price
AM - MEDIUM AQUAFALLS				
AMM	Replacement Filter Pad	221641	4 lbs.	\$33.29
AMGN	Green Matala Replacement Pad	225898	4 lbs.	\$36.99
AMBE	Blue Matala Replacement Pad	226526	4 lbs.	\$37.89
AMGY	Gray Matala Replacement Pad	228761	4 lbs.	\$41.09
AMSTA	Replacement Stand Inside Filter	240687	5 lbs.	\$62.59
AMBW	Replacement Bolts & Washer Pack	29483	1 lb.	\$14.59
AMLIP	Replacement Waterfall Lip	269549	4 lbs.	\$106.99
AMTS	Replacement Termination Strip	521700	2 lbs.	\$33.39

AL - LARGE AQUAFALLS

ALM	Replacement Filter Pad	236781	5 lbs.	\$56.59
ALGN	Green Matala Replacement Pad	245498	5 lbs.	\$64.99
ALBE	Blue Matala Replacement Pad	246126	5 lbs.	\$65.89
ALGY	Gray Matala Replacement Pad	251513	5 lbs.	\$73.59
ALSTA	Replacement Stand Inside Filter	274035	7 lbs.	\$113.89
ALBW	Replacement Bolts & Washer Pack	215207	2 lbs.	\$23.39
ALLIP	Replacement Waterfall Lip	288464	6 lbs.	\$136.09
ALTS	Replacement Termination Strip	126321	3 lbs.	\$40.49



RETAIL FRIENDLY

BBM2B

Nylon Media Bags

- Used in all of our Eco-Series and Pro-Series filters, these tough nylon media bags will last for many years and can hold all types of large media
- MB21 and MB22 are 1/4" mesh and have drawstring with push button release
- MB18F is 3/16" fine mesh and has drawstring with push button release



Filter Parts



RETAIL FRIENDLY

FFM2B

Part #	Description	Dimensions	Stocking Code	Ship Weight	List Price
MB18F	Media Bag, 3/16" fine mesh	18" x 30"	311871	1 lb.	\$17.59
MB21	Media Bag, 1/4" mesh	21" x 30"	412621	1 lb.	\$18.69
MB22	Media Bag, 1/4" mesh	22" x 26"	712623	1 lb.	\$18.69
FFM2B	MB21 Media Bag filled with 2 cu. ft. Filter Floss*	21" x 30"	533640	4 lbs.	\$47.49
BBM2B	MB21 Media Bag filled with 2 cu. ft. Bio-Blox*	21" x 30"	232499	6 lbs.	\$49.99

*See page 76 for more information on these and other media



Skimmer Replacement Parts

ECO-SERIES

Part #	Description	Dimensions	Stocking Code	Ship Weight	List Price
PS3B	Tempo Basket	10 ³ / ₄ " x 6 ¹ / ₂ " x 3 ⁵ / ₈ "	912243	2 lbs.	\$17.49
PS4B	Prelude Basket	10 ³ / ₄ " x 6 ¹ / ₂ " x 3 ⁵ / ₈ "	612241	2 lbs.	\$17.49
PS610B	Melody/Ovation Basket	16" x 8 ³ / ₄ " x 10"	817561	3 lbs.	\$25.09
PS4M	Prelude Mat	10" x 6 ¹ / ₄ "	58320	2 lbs.	\$11.89
PS6M	Melody Mat	15 ¹ / ₄ " x 11"	49169	2 lbs.	\$13.09
PS10M	Ovation Mat	15 ¹ / ₂ " x 15 ¹ / ₈ "	910284	2 lbs.	\$14.69
PS4P	Prelude Partition	10 ³ / ₄ " x 11 ³ / ₄ "H	712472	2 lbs.	\$19.19
PS6P	Melody Partition	19 ³ / ₄ " x 19 ³ / ₈ "H	323658	3 lbs.	\$36.39
PS10P	Ovation Partition	16 ¹ / ₄ " x 23 ¹ / ₄ "H	821773	4 lbs.	\$33.49
PS4L	Prelude Lid	14" x 13 ¹ / ₂ "	422743	3 lbs.	\$32.49
PS6L	Melody Lid	22 ¹ / ₂ " x 20 ¹ / ₂ "	525052	4 lbs.	\$35.79
PS10L	Ovation Lid (black)	20" x 19 ¹ / ₂ " x 1"	229462	4 lbs.	\$42.09
PS10ML	Ovation Molded Lid (tan)	25" x 23" x 2 ¹ / ₂ "	144025	9 lbs.	\$62.89



PRO-SERIES

PMLN	Debris Net for Mini	13" x 13"	317957	2 lbs.	\$26.59
P1LN	Debris Net for Small	20"L x 11 ¹ / ₄ "H	825789	2 lbs.	\$38.19
P2LN	Debris Net for Large	24 ¹ / ₂ "L x 20"H	631311	4 lbs.	\$46.39
PSA57N	Debris Net for PSA5000/7000	14" x 16"	224772	2 lbs.	\$36.69
PSA911N	Debris Net for PSA3600/9000/11000	16" x 16"	525514	3 lbs.	\$37.79
PSMM*	Matala Pad for Mini	12" x 16"	39727	1 lb.	\$13.89
PS1VM*	Matala Pad for Small	14" x 17"	311126	2 lbs.	\$15.89
PS2VM*	Matala Pad for Large	16" x 26"	321550	4 lbs.	\$30.79
PSMLID	Lid for Mini	21 ¹ / ₂ " x 16 ¹ / ₂ "	332107	5 lbs.	\$49.39
PS1LID	Lid for Small	32" x 21 ³ / ₄ "	374096	14 lbs.	\$113.99
PS2LID	Lid for Large	47" x 24"	8104972	20 lbs.	\$161.49
PSMDV	Divider - Mini	12 ⁵ / ₈ " x 18"H	339848	1 lb.	\$61.29
PS1VDV	Divider - Small	16" x 18 ³ / ₈ "H	349788	3 lbs.	\$76.59
PS2VDV	Divider - Large	16 ¹ / ₈ " x 28 ¹ / ₄ "H	354927	6 lbs.	\$84.49
PSMR*	Filter Brush Rack - Mini	14 ¹ / ₄ " x 18"H	234907	2 lbs.	\$53.69
PS1R*	Filter Brush Rack - Small	16 ¹ / ₂ " x 18"H	743223	5 lbs.	\$66.49
PS2R*	Filter Brush Rack - Large	19" x 26"H	461615	8 lbs.	\$94.79
PSAR	Filter Brush Rack - Axiom Skimmers	16 ¹ / ₂ " x 18"H	143220	5 lbs.	\$66.49
PSF6A	6" Faceplate & Weir - fits PSM Skimmers		841591	2 lbs.	\$63.99
PSF8A	8" Faceplate & Weir - fits PS1, PSMEK Skimmers		246739	2 lbs.	\$71.89
PSF16	16" Faceplate & Weir - fits PS2 Skimmers		664805	4 lbs.	\$99.69
PSF6B	6" Faceplate & Weir - fits PSA5000 Skimmers		442370	2 lbs.	\$65.19
PSF8B	8" Faceplate & Weir - fits PSA3600/7000/9000 Skimmers		448872	2 lbs.	\$75.19
PSF10	10" Faceplate & Weir - fits PSA11000 Skimmers		955373	3 lbs.	\$85.19

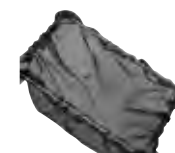

*Assembled in the USA

EasyPro Pond and Waterfall Kits are a popular choice for landscapers and contractors wanting top quality, easy to install water features. Complete kits ensure that all components work together and are properly sized. Below is a diagram showing how an EasyPro pond kit works:

Cross Section of a Pond Kit

Flexible PVC Pipe

Carries water from skimmer to AquaFalls filter. Makes installation easier!

Extension Tube

Optional - Allows skimmer to sit back from edge of pond making it much more natural looking.

AquaFalls Filter

Bury in the ground and when installed properly are completely hidden from view. Filters require minimal (usually once per year!) cleaning and keep the pond sparkling clean. Filter tubs also provide an ideal base for waterfalls and streams.

Skimmer

Hide pump and plumbing from view. Greatly reduces pond maintenance by skimming debris from surface. Provides an ideal spot for an automatic fill valve which replaces water due to evaporation.

45 MIL Rubber Liner

Strong yet flexible liners have 20 year warranty.

Bottom Drain

Optional bottom drain increases circulation and cleaning of pond.

Underlayment

Provides protection against punctures in liner from sharp rocks or tree roots.

Covering liner with rocks and gravel provides additional surface area for bacteria, also hides and protects liner. Rocks and gravel look more natural than bare liner.

Pond Kit Comparison Chart

Below is a quick look at all EasyPro stock pond kits:

Part#	Pond Size	Liner Size	Gallons in Pond	Skimmer	Filter	Pump	Flex Pipe	Pump Warranty
EPK66	6' x 6'	10' x 13'	400	PS4E	WF10E	EP1750	1 1/4" x 25'	3 years
EPK810	8' x 10'	15' x 15'	900	PS6E	WF18E	EP2200	1 1/2" x 25'	3 years
EPK1015	10' x 15'	17' x 20'	1700	PS6E	WF29E	TH150	2" x 25'	2 years
EPK1520	15' x 20'	22' x 25'	3400	PS10E	WF60E	TH400	2" x 25'	2 years
ET66FB	6' x 6'	10' x 10'	400	PSMFB	AT	EP2200	1 1/4" x 25'	3 years
ET610FB	6' x 10'	10' x 14'	675	PSMFB	AT	EP2200	1 1/4" x 25'	3 years
ET811FB	8' x 11'	12' x 15'	1000	PSMFB	AT	EP2200	1 1/4" x 25'	3 years
ES66FB	6' x 6'	10' x 10'	400	PSMFB	AS	EP2200	1 1/2" x 25'	3 years
ES611FB	6' x 11'	10' x 15'	750	PSMFB	AS	EP2200	1 1/2" x 25'	3 years
ES811FB	8' x 11'	12' x 15'	1000	PSMFB	AS	EP2200	1 1/2" x 25'	3 years
ES11AFB	11' x 11'	15' x 15'	1400	PS1FB	AS	TH150	1 1/2" x 25'	2 years
ES16AFB	11' x 16'	15' x 20'	2000	PS1FB	AS	TH150	1 1/2" x 25'	2 years
EM1116FB	11' x 16'	15' x 20'	2000	PS1FB	AM	TH250	2" x 25'	2 years
EM1616FB	16' x 16'	20' x 20'	2900	PS1FB	AM	TH250	2" x 25'	2 years
EM1621FB	16' x 21'	20' x 25'	3800	PS1FB	AM	TH400	2" x 50'	2 years
EM2121FB	21' x 21'	25' x 25'	4950	PS1FB	AM	TH400	2" x 50'	2 years
EM2126FB	21' x 26'	25' x 30'	6150	PS1FB	AM	TH400	2" x 50'	2 years
EL2424	24' x 24'	30' x 30'	10000	PS2FB	AL	TM9500	3" x 50'	2 years
EL2434	24' x 34'	30' x 40'	13500	PS2FB	AL	TM13500	3" x 50'	2 years
EL3434	34' x 34'	40' x 40'	18000	PS2FB	AL	TM13500	3" x 75'	2 years

Eco-Series Pond Kits

Eco-Series Pond Kits are an excellent value. Each kit includes all necessary items to build a top quality feature. See chart below for exact sizes on pumps, skimmers, filters, etc.

ECO-Series®

Kits Include:

- 45 mil rubber liner - **20 Year Warranty**
- Liner underlayment
- Eco-Series skimmer
- Eco-Series filter with media
- Continuous duty pump
- Check valve assembly
- Flexible PVC pipe
- PVC glue

*A Great
"DIY"
Kit!*



RETAIL FRIENDLY

Part #	Pond Size	Liner Size	Skimmer Included	Filter Included	Pump Included	Flex Pipe	Stocking Code	Ship Weight	List Price
EPK66	6' x 6'	10' x 13'	Prelude	Prelude	EP1750	1 1/4" x 25'	4546898	88 lbs.	\$807.69
EPK810	8' x 10'	15' x 15'	Melody	Sonata	EP2200	1 1/2" x 25'	7826303	67 + 93 lbs.	\$1211.19
EPK1015	10' x 15'	17' x 20'	Melody	Melody	TH150	2" x 25'	31075996	78 + 128 lbs.	\$1579.59
EPK1520	15' x 20'	22' x 25'	Ovation	Symphony	TH400	2" x 25'	11512579	260 lbs.	\$2220.89



Recommended Accessories:

Underwater Lighting - page 40 - 46 • Auto Fill Valves - page 38 • Bacteria, Water Treatments - page 67 - 74



Mini Pond Kits

Ideal for Retail Sales

Mini pond kits have everything a do-it-yourselfer needs to build a beautiful, long lasting water feature all in one box.

- A 45 mil rubber liner - **20 Year Warranty**
- Underlayment
- Mini Skimmer with filter brushes
- Mini AquaFalls filter with molded rock lip
- 25' of 1 1/4" PVC flex pipe (not cheap kink free like others use)
- 1 1/4" Check valve assembly
- Silicone sealer and PVC glue
- 2,200 GPH Mag Drive Pump **with three year warranty**

**P
S
E
R
I
E
S**



RETAIL FRIENDLY

Part #	Pond Size	Liner Size	Skimmer Included	Filter Included	Pump Included	Approx. Gallons	Stocking Code	Ship Weight	List Price
ET66FB	6' x 6'	10' x 10'	PSMFB	AT	2200 GPH	400	2705627	103 lbs.	\$1076.49
ET610FB	6' x 10'	10' x 14'	PSMFB	AT	2200 GPH	675	7737923	120 lbs.	\$1123.69
ET811FB	8' x 11'	12' x 15'	PSMFB	AT	2200 GPH	1,000	5770228	125 lbs.	\$1170.79



Recommended Accessories:

Underwater Lighting - page 40 - 46 • Auto Fill Valves - page 38 • Bacteria, Water Treatments - page 67 - 74





Oyster Bay High School (NY)



Small Pond Kits

All Pro-Series "ES" kits include:

Eliminate the time and guess work of assembling a pond package, everything you need is included. All components are top quality and long lasting — providing years of enjoyment to the owner!

- Pro-Series small AquaFalls filter
- Pro-Series skimmer with filter brushes
- Energy efficient submersible pump
- 45 mil rubber liner
- Liner underlayment
- Beneficial bacteria
- 25' of 1 1/2" flex PVC pipe
- Check valve assembly, fittings and instructions
- Three mini LED lights with 45 watt transformer
- Waterfall installation kit (pvc glue, primer, silicone, black foam)

Filter Brushes At No Extra Cost:

Pond kit skimmers come standard with filter brushes! Brushes require less cleaning than traditional filter pads. If you prefer the style with filter pad simply remove the "FB" from the part number when ordering.

UV Option:

The ES11AFB and ES16AFB pond kits include the PS1FB skimmer which has an optional UV upgrade when filter brushes are used, see page 7 for more information. See pages 86 and 88 for more information on pumps included in kits.



Part #	Pond Size	Liner Size	Approx. Pond Gallons	Skimmer Included	Pump Included	GPH Flow	Pump Warranty	Stocking Code	Ship Weight	List Price
ES66FB	6' x 6'	10' x 10'	400	PSMFB	EP2200	2200	3 years	6995631	50 & 76 lbs.	\$1510.89
ES611FB	6' x 11'	10' x 15'	750	PSMFB	EP2200	2200	3 years	31036006	66 & 76 lbs.	\$1569.79
ES811FB	8' x 11'	12' x 15'	1000	PSMFB	EP2200	2200	3 years	71060233	69 & 76 lbs.	\$1605.19
ES11AFB	11' x 11'	15' x 15'	1400	PS1FB	TH150	3100	2 years	41245448	90 & 110 lbs.	\$1887.19
ES16AFB	11' x 16'	15' x 20'	2000	PS1FB	TH150	3100	2 years	81306005	90 & 140 lbs.	\$1975.59

ES Kits include 25' of 1 1/2" flex PVC pipe.



Medium Pond Kits

All medium pond kits include our medium AquaFalls filter and PS1FB skimmer for increased filtering capacity over the small pond kits above.

All Pro-Series "EM" kits include:

- 45 mil Firestone liner
- Liner underlayment
- Medium AquaFalls filter/waterfall base
- PS1FB skimmer
- EasyPro TH pump with two year warranty
- Beneficial bacteria
- 2" flexible PVC pipe
- Check valve assembly
- Three mini LED lights with 45 watt transformer
- Installation kit which includes PVC primer, glue, liner patch, silicone and black foam



All EM pond kits ship complete on one pallet.

Part #	Pond Size	Liner Size	Approx. Pond Gallons	Pump/ GPH @ 5'	Pipe Length	Stocking Code	Ship Weight	List Price
EM1116FB	11' x 16'	15' x 20'	2000	TH250/4100	2" x 25'	31515267	290 lbs.	\$2296.39
EM1616FB	16' x 16'	20' x 20'	2900	TH250/4100	2" x 25'	81596019	310 lbs.	\$2414.19
EM1621FB	16' x 21'	20' x 25'	3800	TH400/5100	2" x 50'	11786366	370 lbs.	\$2697.39
EM2121FB	21' x 21'	25' x 25'	4950	TH400/5100	2" x 50'	91917613	400 lbs.	\$2891.29
EM2126FB	21' x 26'	25' x 30'	6150	TH400/5100	2" x 50'	22018558	430 lbs.	\$3038.49

EM pond kits come standard with PS1FB skimmer (filter brushes). For a skimmer with filter pad - drop letters "FB" from part number



Large Pond Kits

Due to the unique nature of large pond and waterfall applications most of these jobs are custom designed to fit your exact needs. Please fax us a drawing of your project and let us help you design your water feature. Following are a few examples of large pond kits, keep in mind they can be altered to your exact needs!

All Pro-Series "EL" Kits Include:

- 45 mil Firestone liner
- Liner underlayment
- Large Pro-Series skimmer (PS2FB)
- Large Pro-Series AquaFalls filter/waterfall base (AL)
- 9,000 GPH or larger submersible pump
- 3" check valve assembly
- 3" flexible PVC pipe
- One gallon beneficial pond bacteria (ASB128)
- Four underwater lights with transformer
- WIK2 installation kit which includes PVC primer, glue, liner patch, black foam and two tubes of silicone



Greenline Inc. (MI)



Bottom drains are strongly recommended in large ponds to prevent stratification - see EBD4 on page 53.

Large pond kit systems are based on a 3' water depth

Part #	Pond Size	Liner Size	Pump (GPH)	3" Flex Pipe Included	Stocking Code	Ship Weight	List Price
EL2424	24' x 24'	30' x 30'	TM9500 (9000)	50'	43168525	695 lbs.	\$4743.09
EL2434	24' x 34'	30' x 40'	TM13500 (13500)	50'	63593662	360 + 450 lbs.	\$5367.39
EL3434	34' x 34'	40' x 40'	TM13500 (13500)	75'	14023125	510 + 480 lbs.	\$5996.59



Koi Pond Kits

EasyPro sells a wide variety of products geared toward koi ponds. Often these projects become quite elaborate and usually each kit is custom designed to meet the desired look of that feature. Following are a couple koi pond kits designed for small to medium size koi features.

Since every koi pond is uniquely shaped, these kits include everything you need except for liner or underlayment – those can be ordered separately.

Kits Include:

- EasyPro bead filter
- External pump skimmer(s)
- EasyPro external pump
- EasyPro bottom drain (EBD4N)
- UV clarifier
- Eco-Series waterfall spillway
- All plumbing and flex pipe



Part #	Max Pond Size	Spillway Part #/Width	Pump (GPH)	Skimmer	Filter	UV Included	Stocking Code	Ship Weight	List Price
KP3500	3500 Gallon	CF23E/23"	EXP4900	PSMEX	PBF35	AU40	82194421	200 lbs.	\$3265.79
KP5500	5500 Gallon	CF34E/34"	EXP6800	(2) PSMEX	PBF55	AU57	22797830	250 lbs.	\$4187.39



Rainwater Containment Systems

These systems allow you to capture and store rainwater from roof tops, permeable patios, driveways, etc. for later use in irrigation, fountain basin and Just-A-Falls water feature replenishment. Available in 500, 1000 and 2000 gallon capacities or a custom sized system can be matched to your needs.

Each system comes complete with a high pressure, submersible irrigation pump complete with an automatic on/off sensor. You can attach auto fill valves for water features or a garden hose for irrigation (or use a Y on the outlet and use both!). The sensor will automatically turn the pump on anytime the auto fill calls for water or anytime you pull the trigger on the garden hose.

Extra large pond liner is included which can wrap around the top of the reservoir leaving only a small area of exposed stone in the center where the pump is located. This minimizes the visual foot print of the reservoir making it very easy to conceal!



A 1000 gallon system was installed under a future patio area in this backyard setting. The 6' x 11' reservoir area was reduced to only a 24" diameter visible area.



DF26RW

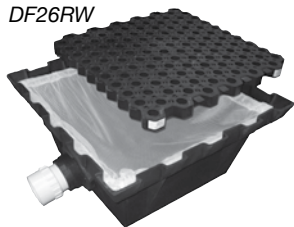

DOWNSPOUT FILTER

This optional downspout filter is used to capture debris from roof water before going into the reservoir. A fine mesh debris net lies just under the grating which is covered with rocks to conceal the filter. In typical applications this net only needs to be cleaned 1 - 2 times per year. A 3" spinweld fitting is installed in the side of the basin and a 3" pvc adapter comes included. Simply connect 3" flexible or rigid pvc pipe between the basin and the reservoir (not included).



See our website for more information on rain containment systems



Our ready-to-install systems include a reservoir, pump and automatic controller that gives you water each time you pull the trigger on your garden hose.

500 GALLON SYSTEM

Reservoir Area - 5.5' x 4.5' x 36" deep

RWC500 Includes:

- 1 JAFM - Pump Vault
- 1 JAFME - Vault Extension
- 14 HSC44 - High Strength Res-Cubes
- 300 PL45 (15' x 20') - 45 mil Liner
- 300 FPU (15' x 20') - Underlayment
- 1 HPC23 - Pump Controller
- 1 EDP75 - High Pressure Pump, 3/4 hp, 115v

1,000 GALLON SYSTEM

Reservoir Area - 7' x 7' x 3' deep

RWC1000 Includes:

- 1 JAFM - Pump Vault
- 1 JAFME - Vault Extension
- 28 HSC44 - High Strength Res-Cubes
- 400 PL45 (20' x 20') - 45 mil Liner
- 400 FPU (2 Pieces 10' x 20') - Underlayment
- 1 HPC23 - Pump Controller
- 1 EDP75 - High Pressure Pump, 3/4 hp, 115v

2,000 GALLON SYSTEM

Reservoir Area - 10.5' x 6' x 4.5' deep

RWC2000 Includes:

- 1 JAFM - Pump Vault
- 3 JAFME - Vault Extension
- 54 HSC44 - High Strength Res-Cubes
- 600 PL45 (20' x 30') - 45 mil Liner
- 600 FPU (2 Pieces 15' x 20') Underlayment
- 1 HPC23 - Pump Controller
- 1 EDP75 - High Pressure Pump, 3/4 hp, 115v

Part #	Description	Stocking Code	Ship Weight	List Price
RWC500	500 Gallon Rainwater System	21562541	415 lbs.	\$2230.59
RWC1000	1000 Gallon Rainwater System	32117210	670 lbs.	\$3050.59
RWC2000	2000 Gallon Rainwater System	53256884	1130 lbs.	\$4743.69
DF26RW	Downspout Filter, 26" x 26" x 12"	6149998	22 lbs.	\$199.99
EDP75	High Pressure Pump, 3/4 HP, 115v	9427197	22 lbs.	\$569.59
HPC23	Pump Controller, automatically turns pump on/off	1224549	5 lbs.	\$299.39

EasyPro offers the largest selection of waterfall spillways in the industry! The Eco-Series spillways are available in 12" to 48" widths while the patented Pro-Series modular system can be made in endless sizes and shapes. Tougher and faster to install than any other spillway on the market.

Waterfall spillways are the perfect choice for Just-A-Falls (pond-less) systems, signs, swimming pool features and other installations where a cascade of water is desired and filtration is not needed.



Huisman Landscape (MI)



Three UWD23 spillways installed by Outdoor Impression (MI)

ECO-Series® Waterfall Diffusers

Tougher and faster to install than any other spillway on the market

- Ideal for use at beginning of streams and in block walls, pools and formal fountains
- Extra strong vertical rib design creates a nearly indestructible diffuser
- 23" wide — can be used in multiples for wider applications
- Recommended flow rate of 25 to 100 GPM
- Dual 2" inlets
- Measures 23" wide x 14" deep x 3 1/2" tall



UWD23



UWD46



Part #	Description	Stocking Code	Ship Weight	List Price
UWD23	23" Waterfall Diffuser	187744	8 lbs.	\$134.99
UWD46	Dual 23" Waterfall Diffusers	8175492	16 lbs.	\$269.99

Ideal for building natural looking waterfalls or formal features!



Diffusers with UWD23CN copper attachment Randy Schmidt (MI)

COPPER SPILLWAY ATTACHMENTS

Add copper spillway attachments for amazing formal features!

Measurements:

UWD23C: 23 1/8" x 7 x 3 1/2"

UWD23CN: 23 1/8" x 7 x 3 1/2"



UWD23C



UWD23CN

Part #	Description	Stocking Code	Ship Weight	List Price
UWD23C	Wide Copper Attachment	9146645	5 lbs.	\$209.49
UWD23CN	Narrow Copper Attachment	6169882	5 lbs.	\$242.69



Viantifalls

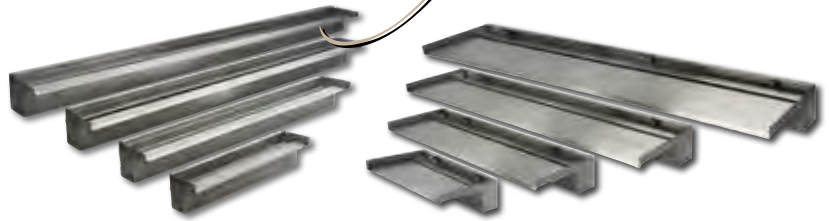

Available with standard 2" lip (above left) or 6" extended lip (above right)!

Stainless steel for maximum strength

- Available in a variety of sizes and styles
- Rated for ten gallons per minute flow per foot of width
- LED light strips can be used on spillways - see page 41
- Internal baffle calms incoming water — creating even, smooth flow over lip
- Ideal for formal features, signs and swimming pool features



Bogert Products (MN)



Waterstone Landscape (MN) installed these Viantifalls spillways with customized burner and lighting

Optional Lighting



LED - Soft White

- LED11WW for 11" spillway
 - LED23WW for 23" spillway
 - LED35WW for 35" spillway
- Use in pairs for longer spillways



LED - Blue

- LED11CB for 11" spillway
 - LED23CB for 23" spillway
 - LED35CB for 35" spillway
- Use in pairs for longer spillways

See page 41 for pricing and ordering information

Part #	Spillway Width	Spillway Lip Style	Quantity 1" Inlets	Recommended Flow (GPH)	Stocking Code	Ship Weight	List Price
SSS11	11 1/2"	2" lip	1	600	7162433	4 lbs.	\$249.89
SSS23	23 1/2"	2" lip	1	1200	9176085	8 lbs.	\$270.89
SSS35*	35 1/2"	2" lip	2	1800	4235758	12 lbs.	\$362.69
SSS47*	47 1/2"	2" lip	2	2400	1265006	17 lbs.	\$407.69
SSS59*	59 1/2"	2" lip	3	3000	8389992	20 lbs.	\$599.99
SSS71*	71 1/2"	2" lip	3	3600	3572843	26 lbs.	\$881.29
SSS611	11 1/2"	6" lip	1	600	2185180	5 lbs.	\$284.89
SSS623	23 1/2"	6" lip	1	1200	3198831	10 lbs.	\$305.89
SSS635*	35 1/2"	6" lip	2	1800	5258509	14 lbs.	\$397.69
SSS647*	47 1/2"	6" lip	2	2400	6299252	23 lbs.	\$460.39
SSS659*	59 1/2"	6" lip	3	3000	2531378	28 lbs.	\$817.49
SSS671*	71 1/2"	6" lip	3	3600	4718894	36 lbs.	\$1105.99

Fittings are not included - Use the fittings below for tubing connections:



MA10	1" PVC Male Adapter (mpt x slip)	71420	1 lb.	\$2.19
STL10T	1" PVC Street Elbow (mpt x slip)	23055	1 lb.	\$4.69
TA100E	1" Barbed 90° Elbow (mpt x barb)	92383	1 lb.	\$3.40

Vianti Falls Kits

Everything you need to build a simple yet beautiful waterfall using the block wall of your choice!

- Molded basin
- Stainless spillway
- EasyPro mag drive pump
- PVC flex pipe and fittings
- Auto fill valve (not included in 11" kits)



New 6" lip kits now available!



Complete kits include everything you need (less the block) including an auto fill valve!

Add the mesmerizing effect of fire to Vianti Falls features!

- The 16" stainless burner features a water cooling tray to prevent any chance of basin overheating and easily ties into the existing pump line
- Burner is designed for use with natural gas, a propane conversion is available
- Complete kit with regulator, gas valve quick connect, 12' hose and propane conversion is available for easy installation using a 20 pound propane tank — ideal for displays or home installations where permanent installation is not feasible

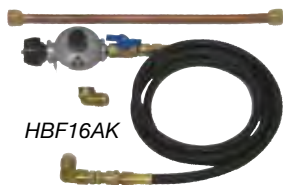

HBF16AK



HBF16



Part #	Description	Pump Included	Basin Included	Stocking Code	Ship Weight	List Price
HB11K	11 1/2" Vianti Falls Kit without Lights	EP850	RBH21	2379340	28 lbs.	\$567.89
HB11KB	11 1/2" Vianti Falls Kit with Blue Lights	EP850	RBH21	1436397	30 lbs.	\$649.29
HB11KW	11 1/2" Vianti Falls Kit with White Lights	EP850	RBH21	4436399	30 lbs.	\$649.29
HB23K	23 1/2" Vianti Falls Kit without Lights	EP1350	FWB48	3569626	54 lbs.	\$871.19
HB23KB	23 1/2" Vianti Falls Kit with Blue Lights	EP1350	FWB48	9666044	55 lbs.	\$1008.99
HB23KW	23 1/2" Vianti Falls Kit with White Lights	EP1350	FWB48	2666048	55 lbs.	\$1008.99
HB35K	35 1/2" Vianti Falls Kit without Lights	EP2200	FWB48	7675331	62 lbs.	\$1033.79
HB35KB	35 1/2" Vianti Falls Kit with Blue Lights	EP2200	FWB48	5769083	63 lbs.	\$1164.29
HB35KW	35 1/2" Vianti Falls Kit with White Lights	EP2200	FWB48	4769080	63 lbs.	\$1164.29
Add "EX" to the end of any Vianti Falls kit above for a system with a 6" extended spillway				822753	—	\$35.00*
HBF16	16" Fire Burner with Plumbing Kit -	-	-	7269772	6 lbs.	\$359.69
HBF16AK	Propane Adapter Kit with 12' hose, regulator & propane converter	-	-	9136191	5 lbs.	\$181.59
PRO40	Propane converter only, for hard pipe installation	-	-	143421	3 lbs.	\$57.89

*Add \$35 list price to standard kit price above



*Dimensional Rates Apply for Viantifalls Kits

ECO-Series®



PV60E

ECO-SERIES PUMP VAULTS

- Low cost way to ensure easy access to the pump in pondless water features
- Makes inspection or maintenance of the pump much easier
- Use flagstone or rock as a cover, ensuring a match to the water feature you are building

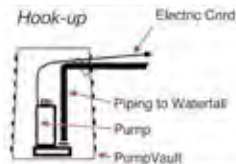

JAFT

MINIATURE PUMP VAULT

- Roto-molded for excellent strength
- Can be used with JAFME extension below
- Ideal for mag drive pumps
- Can be used in small Just-A-Falls or custom built fountain basins

Use these vaults along with the spillways on pages 22-23 to build custom sized "Just-A-Falls" waterfall systems or buy a complete kit on pages 25-27!

Part #	Description	Dimensions (L x W x H)	Max. Flow	Stocking Code	Ship Weight	List Price
PV60E	Eco-Series Pump Vault	14" dia. x 24"	6000 GPH	9122000	12 lbs.	\$187.69
JAFT	Mini Pump Vault	13" dia. x 14 1/2"	3000 GPH	265932	7 lbs.	\$94.19



JAFV

JAFME



PRO-SERIES PUMP VAULTS

- Built heavy duty to withstand the pressure of being buried under rock
- The slots cut in the sides allow water into the pump
- Intake tubes available for JAFM and JAFV to increase flow capacity



PUMP VAULT EXTENSION

- Allows you to dig your reservoir deeper (great for tight areas) and still have easy access to the pump
- Flange around bottom slides right over the top edge of the small vault
- Multiple extensions can be used if needed



JAFM Vault with JAFME Extension

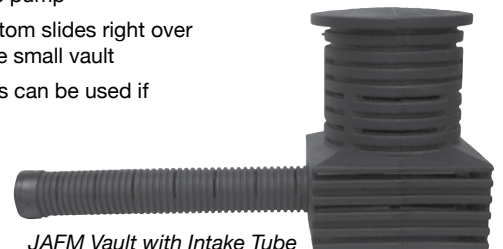

JAFM Vault with Intake Tube

Part #	Description	Dimensions (L x W x H)	Max. Flow	Stocking Code	Ship Weight	List Price
JAFM*	Small Pump Vault	16" x 16" x 22"	7500 GPH	7159313	17 lbs.	\$245.09
JAFV*	Large Pump Vault	24" x 24" x 32"	18000 GPH	6262729	54 lbs.	\$404.19
JAFME	Small Vault Extension	12" tall	—	167597	5 lbs.	\$103.99
JAFM30	Intake Tube for JAFM	4" dia. x 30" long	additional 2500 GPH	532491	3 lbs.	\$49.99
JAFV30	Intake Tube for JAFV	8" dia. x 30" long	additional 5000 GPH	463694	6 lbs.	\$97.99

*Dimensional Rates Apply to JAFM & JAFV

Res-Cubes

Features:

- Reduce rock tonnage
- Reservoir can be made smaller because of the increased water percentage due to less rock being used
- Increase reservoir water capacity from 40% with rock to 90%+ with Res-Cubes
- Installation time is reduced considerably - smaller reservoir hole means less digging, less liner and less labor

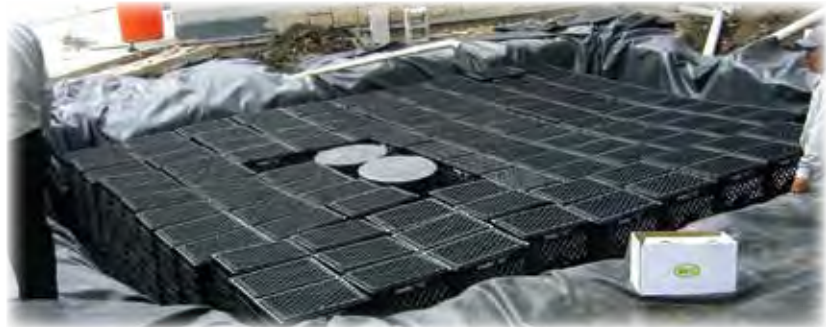

Xavier State University, Chicago, used 334 Res Cubes in this rainwater collection feature, by Kinsella Landscaping (IL)

STANDARD RES-CUBES

- A great way to simplify installation of Just-A-Falls, formal fountains and other basins typically using a large quantity of rock
- Sturdy plastic cubes can be stacked together to partially or totally fill a reservoir
- Dramatically reduces the labor involved, reservoir size and material cost



JAFRC



Sinacori Landscape (MI)

HIGH STRENGTH RES-CUBES

- Use in high weight bearing features
- Ideal for use in Just-A-Falls and pondless features using large boulders
- Ships unassembled to save space, quick and easy assembly on site
- Can be used under patios, pathways, sidewalks, etc.
- Great for retention and recycling of rain water
- HSC22 equals 2.4 cu. ft. of space
- HSC44 equals 4.4 cu. ft. of space
- **Sold in pairs only!**

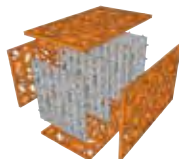

HSC44

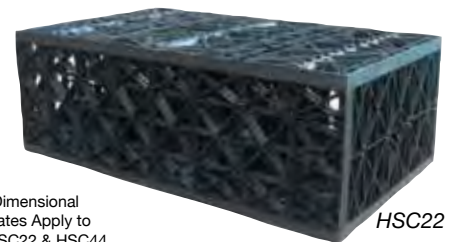

HSC22

Part #	Description	Dimensions (L x W x H)	Gallons Each	Pallet Quantity	Stocking Code	Ship Weight	List Price Each
JAFRC	Res-Cube, Standard	19" x 13" x 11"	11 1/2	75	616637	5 lbs.	\$25.59 each
HSC22*	Res-Cube, High Strength, Half	27" x 16" x 9 1/2"	17	60	926792	23 lbs.	\$39.69* each
HSC44*	Res-Cube, High Strength	27" x 16" x 17 1/2"	31 1/2	60	335638	30 lbs.	\$52.79* each

*Priced individually but sold in pairs only, ship weight is for pair

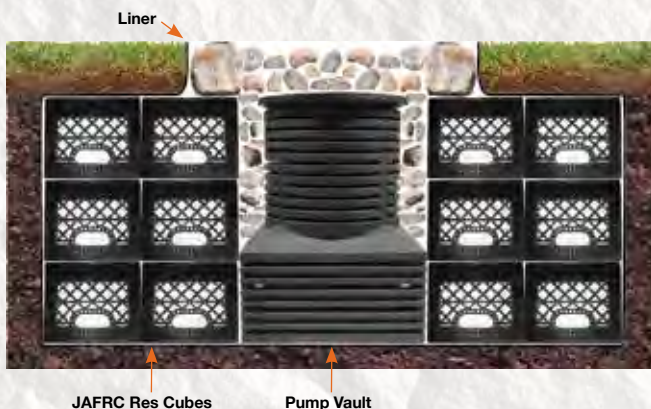

Building "Smaller" Reservoirs...

It's common knowledge that a reservoir has to be built large enough to hold adequate water for the size feature you are building. On large projects the reservoir can get very large. Making a natural looking stone bottom can be a challenge.

EasyPro designers often oversize the liner on the reservoir allowing you to wrap liner over the top of the cubes and greatly reduce the size of visible stone area (see illustration at left).



Allendale Aquatics (MI)

The Installation of Eco-Series Spillways is Easy!

- A** Inlet spinweld comes installed, simply connect incoming supply line
- B** Connecting liner takes only seconds using patented Spliner Lock system
- C** Fill spillway with gravel/small cobble stone, plug in pump and enjoy!

ECO-Series®

One piece waterfall spillways ideal for creating pondless style water features

- Roto-molded for excellent strength
- Easy installation — liner attaches to spillway using the patented “Spliner Lock” system - no silicone, no bolts, no tools!
- Dual inlets — 2" spinwelds (pre-installed) allow for easy plumbing into either end, a plug for unused end is included, CF12E has one 1½" inlet pre-installed
- 4" diffuser tube lays across the bottom of the spillway between inlet fittings
- Water enters from either end (or both ends) and spreads out evenly across width of spillway
- Gravel can be used to fill the inside of the spillway creating a natural, even looking waterfall



Faux stone is available for CF18E & CF23E

Simply wrap liner over the spliner bar, push up into spliner groove and twist the locking knobs into place. Fast, easy, leakproof installation without silicone, bolts or tools!

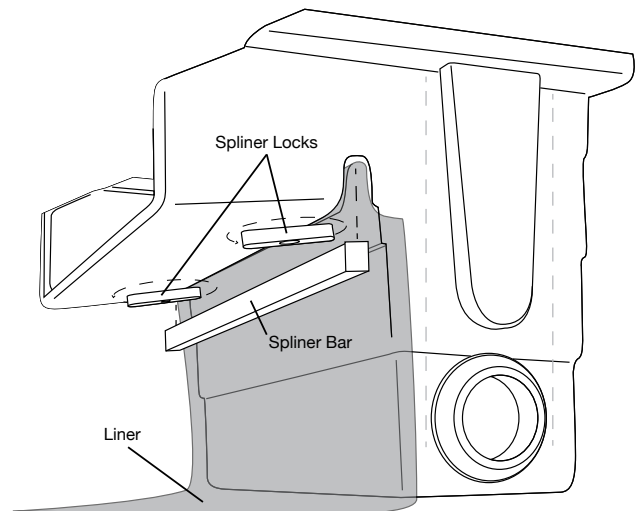

Part #	Description	Dimensions (L x W x H)	Inlet Size/Location	Stocking Code	Ship Weight	List Price
CF12E	12" Spillway	16½" x 13" x 9"	1½" Back	448578	5 lbs.	\$69.39
CF18E	18" Spillway	22" x 14½" x 13½"	2" Both Ends	4113742	11 lbs.	\$174.99
CF23E	23" Spillway	27¾" x 14½" x 13½"	2" Both Ends	8127391	12 lbs.	\$195.99
CF34E	34" Spillway	37¼" x 14½" x 13½"	2" Both Ends	3168992	22 lbs.	\$259.99
CF48E	48" Spillway	52½" x 14½" x 13½"	2" Both Ends	6227495	27 lbs.	\$349.99
CF18FS	18" Faux Stone	—	—	124049	2 lbs.	\$36.99
CF23FS	23" Faux Stone	—	—	732230	3 lbs.	\$49.59



Stone Forest Materials (GA)

These waterfall spillways have a plastic grating just below the water level that not only keeps the walls from bowing when buried in the ground, but also allows you to stack 3" - 4" of rock to hide the spillway.



P
SERIES
O

EWS18
EWS34
EWS50



EWLR3 (1), EWI16 (3), EWO16 (3)

The first expandable waterfall spillway on the market!

With straight, inward or outward curving sections you can custom design the shape of your feature. Waterfalls up to 34' wide have been built using this system.

- Straight spillways of 18", 34" and 50" come assembled, curved spillways and spillways over 50" come unassembled due to shipping constraints. The straight, inward and outward pieces are interchangeable and can be used in any combination.
- Dual bulkheads (included) allow incoming water from either or both ends. A plug is included for whichever end is not used.
- Easy bolt together assembly — no drilling needed!
- Waterfall spillways are designed to sit inside the liner eliminating any concerns of leaking. The liner simply goes under the spillway and up the back side. The bulkhead fitting secures liner to tub where the hose enters the spillway.



EWLR2 (1), EWI16 (3)



EWLR2 (1), EWO16 (3)



Part #	Description	Inlet/Bulkhead	Spillway Width	Stocking Code	Ship Weight	List Price
EWS18	18" Straight - Assembled	2" inlet	18"	1162495	19 lbs.	\$249.99
EWS34	34" Straight - Assembled	2" inlet	34"	9259993	30 lbs.	\$399.99
EWS50	50" Straight - Assembled	3" inlet	50"	5370497	54 lbs.	\$569.99
EWE16	16" Extension Straight	—	16"	188006	12 lbs.	\$135.39
EWI16	16" Extension Inward	—	16"	298797	15 lbs.	\$151.99
EWO16	16" Extension Outward	—	16"	397498	15 lbs.	\$149.99
EWLR2	Left and Right set unassembled (for 2" pipe)	2"	18"	6153076	18 lbs.	\$235.49
EWLR3	Left and Right set unassembled (for 3" pipe)	3"	18"	8200065	18 lbs.	\$307.79



Makes an incredible display at trade shows and retail stores

AFK72R Includes:

- Custom built liner and underlayment for a 7' diameter x 11" deep pool
- Concrete 24" round fire box with 12" natural gas burner and lava rock
- EP2200 pump
- UWD23 23" waterfall diffuser with UWD23C copper flange
- All tubing, valves, fittings and instructions
- Ships UPS in three boxes!



Fire & Water Kits

These self contained features combine the mesmerizing effects of both fire and water!

- Kits designed for use with the block of your choice

AFK48 Includes:

- Custom built, shaped vinyl liner for a 48" x 43" x 11" deep pool
- Concrete 22" x 22" fire box, 12" natural gas burner and lava rock
- EP2200 pump
- UWD23 23" waterfall diffuser with UWD23C copper flange
- Copper sleeve around fire box
- All tubing, valves, fittings and instructions
- A propane conversion is available individually for hard pipe propane installations. Also a kit can be purchased with conversion, regulator, gas valve and 12' hose — everything needed for use with a 20 pound propane tank.



Part #	Description	Stocking Code	Ship Weight	List Price
AFK72R	Fire & Water Kit - Round	5948996	78, 32, 45 lbs.	\$1459.99
AFK48	Fire & Water Kit - Square	21260998	140 lbs.	\$1939.99
PRO90	Propane Conversion - Hard Plumbed	143421	3 lbs.	\$57.89
AFK90AK	Propane Kit - for 20 lb. tanks	9136340	5 lbs.	\$181.79



FWK23

Formal Waterfall Kits

These kits will be an instant attraction in any setting when used along with a wall block of your choice

Available in two styles, as a waterfall into pondless style basin or waterfall into small, above ground pool. Either way creates a beautiful feature in a small area.

Add the LED23 light strip (page 41) in white or blue for a dazzling night time display!

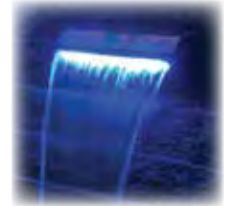

Both Kits Include:

- 45 mil rubber liner
- Underlayment fabric
- Mag drive pump - 2200 gph with three year warranty
- 23" waterfall diffuser (UWD23)
- Copper lip (UWD23C)
- Flex pipe and fittings

Pondless Style Also Includes:

- Pump vault (JAFM)
- Eight Res-Cubes (JAFRC)



*Dimensional Rates Apply on FWK23P

FWK23P

Part #	Description	Liner Size	Pump Included	Stocking Code	Ship Weight	List Price
FWK23	Formal Waterfall Kit, without Pond	15' x 20'	EP2200	3970857	45, 28, 89, 21 lbs.	\$1458.09
FWK23P*	Formal Waterfall Kit, with Pond	10' x 10'	EP2200	8512994	75 lbs.	\$766.59

On the next three pages you will find a variety of complete Just-A-Falls kits. Each kit comes with everything you need to build beautiful streams and waterfalls. Please remember if one of these kits does not fit your needs, we can custom design a kit for you! Fax or email your layout and we will provide you a quote for materials needed to meet your requirements.

Mini Just-A-Falls Kit

This mini kit is perfect for those wanting the sound of water but are short on space!

Includes:

- 45 mil rubber liner
- 12" waterfall spillway
- Two Res-Cubes
- 1800 gph direct drive pump
- Pump outlet assembly
- Liner underlayment
- Pump vault
- Flexible PVC pipe
- PVC glue



RETAIL FRIENDLY



Part #	Stream Length	Liner Size	Basin Size L x W x D	Vault	Flex Pipe	Pump Included	Spillway Width	Stocking Code	Ship Weight	List Price
JAF9E*	3' Stream	7' x 10'	3' x 3' x 18"	JAFT	1 1/4" x 7'	1800 gph	12"	9359373	69 lbs.	\$535.69

ECO-Series® Just-A-Falls Kits

Designed for ease of installation, ideal for the do-it-yourselfers.

Includes:

- 45 mil rubber liner
- Liner underlayment
- Eco-Series pump vault
- Flexible PVC pipe
- Eco-Series waterfall spillway
- PVC glue
- Continuous duty pump
- Check valve assembly

Recommended Accessories:

- Underwater lighting - pages 40 - 46
- Water fill box and auto fill valves - page 38
- Algae control - page 71 and 73
- Res-Cubes - page 21 (see quantity information below)



RETAIL FRIENDLY

American Patio Creations (CA)



Part #	Stream Length	Liner Size	Basin Size L x W x D	Vault	Flex Pipe	Pump Included	Spillway Width	Stocking Code	Ship Weight	List Price
JAF5E*	7' Stream	10' x 20'	5' x 5' x 2'	PV60E	1 1/2" x 25'	EP2200	18"	5637247	110 lbs.	\$965.49
JAF6E*	12' Stream	10' x 25'	5' x 5' x 2'	PV60E	1 1/2" x 25'	EP3200	23"	1709233	127 + 13 lbs.	\$1072.99
JAF7E*	15' Stream	12' x 30'	6' x 7' x 2'	PV60E	2" x 25'	TH400	34"	41024555	100 + 15 + 67 lbs.	\$1549.89
JAF8E	20' Stream	15' x 37'	8' x 10' x 2'	PV60E	2" x 33'	TH750	48"	71366366	282* lbs.	\$2060.39

STANDARD RES-CUBES NEEDED: JAF5E/6E (5' x 5' basin) = 24 • JAF7E (6' x 7' basin) = 46 • JAF8E (8' x 10' basin) = 86

NEW



Dave Poverski (WI)

Just-A-Falls Kits

Complete kits for building beautiful waterfalls and streams

Kits Include:

- 45 mil rubber liner
- Pump discharge assembly
- Underlayment
- UWD23 Waterfall spillway (28' kit has two)
- EasyPro pump vault
- Flexible tubing
- Submersible pump
- Reservoir cubes
- Installation kit with glue, foam and fittings

8' STREAM



4' x 4' x 2' Reservoir
#JAF8W

16' STREAM



5' x 5' x 2' Reservoir
#JAF16W

24' STREAM



6' x 6' x 2' Reservoir
#JAF24W

28' STREAM



6' x 6' x 2 1/2' Reservoir
#JAF28W

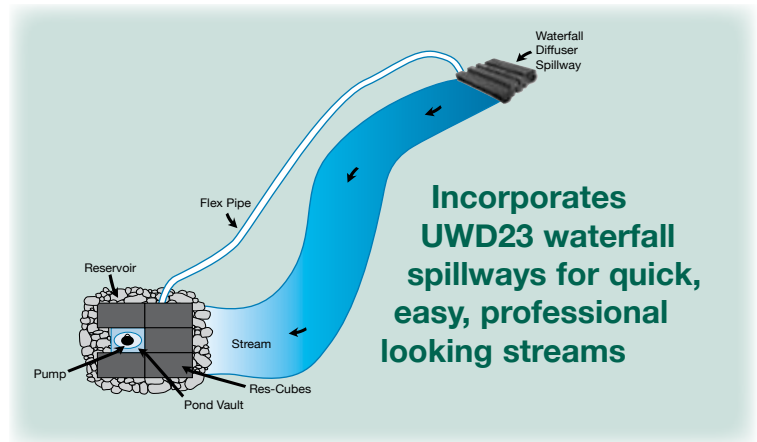

JUST-A-FALLS KITS WITH WATERFALL DIFFUSERS:

Part #	Stream Liner Size	Reservoir Liner Size	Vault	Flex Pipe	Pump Included	Res-Cubes Included	Stocking Code	Ship Weight	List Price
JAF8W	7' x 10'	10' x 10'	JAFM	1 1/4" x 25'	EP2200	3	4729505	106 + 43 lbs.	\$1101.89
JAF16W	7' x 20'	10' x 12'	JAFM	2" x 25'	EP4700	5	1947773	102 + 97 lbs.	\$1426.69
JAF24W	8' x 30'	12' x 15'	JAFM	2" x 50'	TH400	7	91305582	338 lbs.	\$1959.69
JAF28W	10' x 33'	15' x 15'	JAFM	2" x 50'	TH750	7*	81809698	473 lbs.	\$2716.69

*JAF28W also includes seven HSC22 half cubes

Water Features
of Texas (TX)

Just-A-Falls Kits

Buy a complete kit and save!

Just-A-Falls kits include everything you need to build a beautiful waterfall including:

- 45 mil rubber liner
- Underlayment
- EasyPro pump vault
- Submersible pump
- Check valve assembly
- Waterfall spillway
- Flexible PVC pipe
- WIK installation kit

Installed by home owner
Dennis VanderStelt (MI)



Stout Landscaping (MI)

P
S
E
R
I
O

ups *Dimensional Rates Apply on JAF1 & JAF2 Kits

JUST-A-FALLS KITS:

Part #	Stream Length	Liner Size	Basin Size L x W x D	Vault	Flex Pipe	Pump Included	Spillway Width	Stocking Code	Ship Weight	List Price
JAF1*	7'	10' x 20'	5' x 5' x 2'	JAFM	2" x 25'	TH150	18"	3845644	127 + 20 lbs.	\$1284.99
JAF2*	11'	10' x 25'	5' x 6' x 2'	JAFM	2" x 25'	TH400	34"	61091333	140 + 32 lbs.	\$1659.69
JAF3	18'	15' x 40'	8' x 10' x 3'	JAFV	3" x 33'	TM9500	50"	41918707	430 lbs.	\$2872.99
JAF4	30'	20' x 50'	10' x 12' x 3'	JAFV	3" x 50'	TB12000	82"	12755547	370 + 300 lbs.	\$4075.09

Above kits are available with the necessary Res-Cubes figured in! Using cubes reduces the reservoir size needed as well as the amount of rock. The liner size is the same so building a smaller reservoir leaves more liner for a longer stream. All other components in kits are the same as shown above.

JUST-A-FALLS KITS WITH STANDARD RES-CUBES:

Part #	Stream Length	Res-Cubes Included	Basin Size (L x W x D)	Stocking Code	Ship Weight	List Price
JAF1RC	7'	18	5' x 4' x 2'	21087791	260 lbs.	\$1658.39
JAF2RC	11'	24	5' x 5' x 2'	31416010	315 lbs.	\$2160.19
JAF3RC	22'	69	6' x 7' x 3'	32913095	436 + 385 lbs.	\$4406.79
JAF4RC	34'	96	8' x 8' x 3'	64134749	370 + 300 + 480 lbs.	\$6205.19

Contact us for free design assistance on custom Just-A-Falls projects!

ECO-Series®

Installation Basics



ECO-Series® Low Cost Fountain Basins



- Clear span grating — no legs for easy pump installation and removal
- Designed for concrete blocks to sit under grating which greatly increases load capacity!
- 100 pound load rating with grating only, 500+ pounds when used with blocks
- 40" and 48" sizes available

Optional fine screen mesh
Part #FSB18

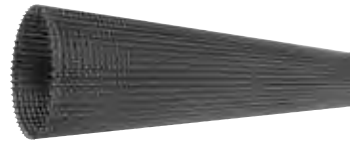

Ideal for use with light weight resin type statuary pieces

Part #	Description	Capacity	Height	Stocking Code	Ship Weight	List Price
FBL40	40" basin w/bench grating	30 gallons	11 ³ / ₄ "	9168992	24 lbs.	\$259.99
FBL48	48" basin w/bench grating	46 gallons	11 ³ / ₄ "	2194998	35 lbs.	\$299.99
FSB18	Optional Fine Screen for FBL40/48	—	—	67495	2 lbs.	\$9.99

ECO-Series® Heavy Duty Fountain Basins



- Molded support grates have multiple legs for increased load capacity
- Ideal for use with concrete statuary, vases, rocks and fountains
- Available in four sizes — 28", 40", 48" and 58"
- Four access doors (on 40" and larger) allow for multiple pumps, auto-fill, underwater lights or can be used as plant pockets
- Roto-molded for superior strength

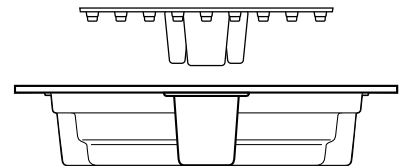

Eco-Series Basins have molded columns that transfer the weight of the statuary down to the ground below it. These columns can be filled with concrete creating "pillars" under heavy statuary.



Part #	Description	Capacity	Height	Stocking Code	Ship Weight	List Price
FB28E*	28" basin w/molded stand	19 gallons	12"	3129997	21 lbs.	\$199.99
FB40E	40" basin w/molded stand	30 gallons	11 ³ / ₄ "	8246991	33 lbs.	\$379.99
FB48E	48" basin w/molded stand	46 gallons	11 ³ / ₄ "	7272990	46 lbs.	\$419.99
FB58E	58" basin w/molded stand	65 gallons	11 ³ / ₄ "	4409494	64 lbs.	\$629.99

Half Basins

Ideal for use with wall block



- Can be installed on decks, patios, indoors — all above grade or buried
- Half circle design fits snug to wall
- Includes anti-splash strip to minimize water loss, an optional larger splash mat is available for use with extended lip style spillways
- Use WFS37 or WFS50 auto-fill valves (page 38) to maintain water level
- Roto-molded, one piece design — super easy to install
- 1" threaded outlet
- 48"L x 24"W x 15 1/2"H



FWB48 Basin with optional FWB48SM splash mat



Part #	Description	Capacity	Stocking Code	Ship Weight	List Price
FWB48*	48" half basin	35 gallons	7188493	28 lbs.	\$289.99
FWB48SM	14" x 39" Splash Mat	-	114942	3 lbs.	\$22.99



Carolina WaterScapes (NC)



See Page 36 for Complete Kits!

Pro-Series Basins

Roto-molded for superior strength

- Ships complete and is engineered to be self supporting, so no cement blocks or other props are needed to support the grating (see photos below)
- Has the thickest, strongest grating of any similar product and features a pump access door for easy pump removal/service
- Both basins below include fine mesh screen



Efb50

Efb26

- **Efb50 Large Basin** — Measuring 50" x 50" and 14" deep, this basin is ideal for large individual features or can hold multiple smaller pieces for a truly impressive display. Pumps up to 3200 GPH can be used!

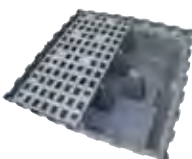

- **Efb26 Small Basin** — Measures 26" x 26" and is 12" deep. Ideal for small statues, vases or rocks where splash is minimal. Mag drive pumps from 120 GPH to 600 GPH are recommended.



Part #	Description	Capacity	Stocking Code	Ship Weight	List Price
Efb26*	26" basin	15 gallons	1136496	19 lbs.	\$209.99
Efb50	50" basin	80 gallons	8279490	65 lbs.	\$429.99





Real Basalts

Few things can match the simple beauty of real basalt columns

- Each column is core drilled with a 1 1/4" (32 mm) hole from end to end, the last 1 1/2" is enlarged to 1 3/8" (37 mm) to hide light ring (page 35)
- Recommended flow rate of 200 - 400 GPH per column
- Ideal for use with FBL40 or FBL48 basins, use concrete blocks in basin for added support for these heavy weight columns
- Basalts can be ordered individually or in a three piece set - order plumbing kit separately on page 35
- Polished tops spill water from all sides

Due to natural characteristics of the basalts - the size, weight and number of sides will vary



LED statuary light sets available on page 35 for basalts on this page



HBS35 Sloped Top Basalt



For protection, these basalts ship on pallets. Combine with basins, pumps, etc. for maximum freight savings!

Part #	Description	Approximate Diameter	Stocking Code	Approximate Ship Weight	List Price
HBR10	10" Polished Top Basalt Column	6" - 8"	383997	38 lbs.	\$119.99
HBR14	14" Polished Top Basalt Column	7" - 9"	2108491	53 lbs.	\$154.99
HBR20	20" Polished Top Basalt Column	7" - 9"	9146990	77 lbs.	\$209.99
HBR27	27" Polished Top Basalt Column	8" - 11"	4192498	106 lbs.	\$274.99
HBR35	35" Polished Top Basalt Column	8" - 11"	6230995	137 lbs.	\$329.99
HBR3A	Three pack Basalt Columns - 10", 14", 20"	varies	7305549	170 lbs.	\$436.49
HBR3B	Three pack Basalt Columns - 14", 20", 27"	varies	1403193	235 lbs.	\$575.99
HBR3C	Three pack Basalt Columns - 20", 27", 35"	varies	8513442	320 lbs.	\$733.49
HBS35	35" Sloped Top Basalt Column	8" - 11"	3230997	135 lbs.	\$329.99



Large Basalt Columns

Take your bubbling rock installations to a whole new level with these large basalts

- Sold as three piece set, these natural basalts are ideal for commercial and upscale residential installations
- 14" to 18" average diameter
- 3', 5' and 7' tall, natural cut tops
- 2" inlet hole is core drilled in the side for use with 1 1/2" pipe, smooth bottom allows for easier installation



For protection, these basalt kits ship in crates

Rivertown Landscapes (MI)



Part #	Description	Approximate Diameter	Stocking Code	Approximate Ship Weight	List Price
HBR3PK	Three Piece Real Basalt Column Kit	14" - 18"	81822492	2200 lbs.	\$2429.99

Basalt Kits

Complete kits for easy, professional installations

Kits Include:

- Your choice of real basalt columns on top of page 30
- FBL40 basin with extra support blocks is used in three pack kits
- RBH21 basin is used in single basalt kit
- Aquasis pump and plumbing kit
- LED lighting kit for a stunning night time display

HBS35KL - One Sloped Top Basalt, RBH21 Basin, AP250 Pump, LED8B Light Kit
HBR3ASL - 3 Short Basalts, FBL40 Basin, AP1000 Pump, LED8B3 Light Kit
HBR3BSL - 3 Medium Basalts, FBL40 Basin, AP1000 Pump, LED8B3 Light Kit
HBR3CSL - 3 Tall Basalts, FBL40 Basin, AP1000 Pump, LED8B3 Light Kit



RETAIL FRIENDLY



Free lights with each basalt kit shown below!

Part #	Description	Stocking Code	Ship Weight	List Price
HBS35KL	Single Basalt Kit	1349449	180 lbs.	\$499.19
HBR3ASL	3 Pack Short Basalts	4601884	225 lbs.	\$876.99
HBR3BSL	3 Pack Medium Basalts	8699531	290 lbs.	\$1019.99
HBR3CSL	3 Pack Tall Basalts	5809785	375 lbs.	\$1169.99

6 Easy Steps For Installation



1. Dig hole, compact ground under basin



2. Install basin - level and backfill



3. Place basalts, using shims provided to level



4. Install pump into basin and plumb columns



5. Install LED lights



6. Fill basin with water, landscape and enjoy!

4 Sided & Large Vases

Make a statement with these new Tranquil Décor pieces

Large blue vase stands 46" tall and is 29" in diameter. Stunning color and stately size makes these pieces impressive additions to the landscape.

- Made from Déco-Crete
- Sold separately or available as a complete kit
- Flow rates from 400 to 800 GPH recommended
- Kit includes vase, 40" Eco-Series basin (FBL40) and an Aquasis pump with flow control

RETAIL FRIENDLY

Déco-Crete



Part #	Description	Stocking Code	Ship Weight	List Price
H4SCR	Four sided square vase, crimson red - 16 1/2" wide x 36" tall	9125992	58 lbs.	\$179.99
HSV45B	Large smooth vase, blue - 29" diameter x 46" tall	1244990	75 lbs.	\$349.99
H4SCRK	Four sided red square vase kit with basin & AP1000 pump	7378503	90 lbs.	\$557.49
HSV45BK	Large blue smooth vase kit with basin & AP600 pump	6440434	110 lbs.	\$645.99

Tranquil Décor

Our Tranquil Décor fountains have the look and texture of traditional materials without the weight or the price tag. Made with an alternative concrete material that is fiber reinforced for strength, this **Deco-Crete** material provides the look and durability of traditional concrete products without the cumbersome weight. Tranquil Décor fountains are individually packaged in foam lined boxes to prevent breakage in shipping and be retail friendly.

RETAIL FRIENDLY



Traditional Vase

- Original double handled vase design
- Includes 3' of tubing
- 200-400 GPH flow recommended
- 14" x 14" x 20" tall

Brown part #: **HDV20T**
 Blue part #: **HDV20B**
 Red part #: **HDV20CR**

Ship weight: 30 lbs.
 Stocking code: 176998
 List Price: **\$109.99**

Deco-Crete

Vase Kit
Add:



Tall Ripple Vase

- Rippled vase design
- Includes 3' of tubing
- 200-400 GPH flow recommended
- 14" x 14" x 30" tall

Brown part #: **HSV30T**
 Red part #: **HSV30CR**

Ship weight: 30 lbs.
 Stocking code: 676991
 List Price: **\$109.99**

Deco-Crete

Vase Kit
Add:



Smooth Vase

- Soothing, smooth vase design
- Includes 3' of tubing
- 200-400 GPH flow recommended
- 19" x 19" x 21" tall

Blue part #: **HSV21B**
 Terra part #: **HSV21R**
 Brown part #: **HSV21T**

Ship weight: 38 lbs.
 Stocking code: 2111998
 List price: **\$159.99**

Deco-Crete

Vase Kit
Add:



How To Order Select Tranquil Décor Vase Fountain Kits:

Applicable only to vase fountains on this page and two vase fountains on the top of page 33

For a "self contained" fountain:

Add the letter "Z" to the end of the part number for a fountain, above-ground basin (RBC23), pump and tubing kit

Above ground kit list price adder: **\$155.50**
 Stocking code: 7108849



For a standard in-ground fountain:

Add the letter "K" to the end of the part number for a fountain, in-ground basin (RBH26), pump and tubing kit

Below ground kit list price adder: **\$155.50**
 Stocking code: 2108846





Classic Vase Fountain

Black Marble
Part #: **HDV31BM**
31" tall x 14" diameter,
with 3' tubing



Stacked Pebble Vase Fountain

Part #: **NCV20**
20" tall x 12" diameter,
with 3' tubing



Twisted Statuary Column

Part #: **NCT30**
30" tall x 8" diameter,
with 3' tubing



Modern Statuary Column

Part #: **NCM24**
24" tall x 9" diameter,
with 3' tubing

Déco-Crete



Déco-Crete



Déco-Crete

Déco-Crete

Part #	Description	Stocking Code	Ship Weight	List Price
HDV31BM	Classic Vase, black	976994	35 lbs.	\$109.99
NCV20	Stacked Pebble Vase	176993	30 lbs.	\$109.99

Order above vase fountains in a complete kit, see bottom of page 32 for details

Part #	Description	Stocking Code	Ship Weight	List Price
NCM24	Modern Column	876996	26 lbs.	\$109.99
NCT30	Twisted Column	276990	36 lbs.	\$109.99
NCM24K	Modern Column Kit	5185843	26+18 lbs.	\$265.49
NCT30K	Twisted Column Kit	1185847	36+18 lbs.	\$265.49

Above kits include fountain, in-ground basin (RBH26) and pump

Tipped Vase Fountain

- Deep center cavity and large inlet tubing allow for higher flow
- Available in two colors - aged copper and brown
- Includes 3' of 3/4" tubing
- Handles flows up to 1000 GPH
- 14" long x 20" wide x 17" tall

Also Available in Kits

Kits include tipped vase fountain, RBH21 Basin, AP1000 pump and tubing



Déco-Crete

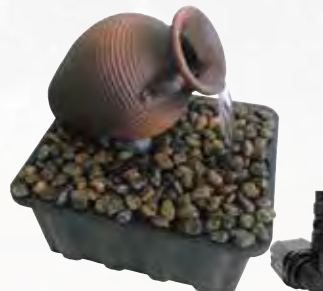

Part #	Description	Stocking Code	Ship Weight	List Price
HTV17C	Tipped Vase - Aged Copper	976994	27 lbs.	\$109.99
HTV17T	Tipped Vase - Brown	376996	27 lbs.	\$109.99
HTV17CK	Tipped Vase Kit - Aged Copper	8241901	27+18 lbs.	\$345.59
HTV17TK	Tipped Vase Kit - Brown	2241905	27+18 lbs.	\$345.59

Tranquil Décor Statuary

Tranquil Décor fountains have the look and texture of traditional materials without the weight and the price tag!

Tranquil Décor fountains on pages 30 through 34 are individually packaged in lined boxes to prevent breakage in shipping and to be retail friendly.



Hampton
Tiered
Fountain

Part #: **NCH45**
45" tall x 26"
diameter, 150
GPH pump with
10' power cord

Déco-Crete



Canyon Creek Self
Contained Waterfall

Part #: **NCC250**
26" x 29" x 20" tall,
250 GPH pump with 15' power cord

Déco-Crete



Bronze Resin
Heron Fountain

Part #: **BHS30**
17" x 9" x 30" tall, with 3' of 1/2" tubing,
200-400 GPH pump recommended



Harmony
Tiered
Fountain

Part #: **NCH48**
48" tall x 31"
diameter, 150
GPH pump with
10' power cord

Déco-Crete



Self Contained
Resin Log Falls

Part #: **NCL21**
26" x 17" x 21" tall,
250 GPH pump with 15' power cord
Déco-Crete basin with resin top



Self Contained
"Cracked" Vase
Resin Fountain

Part #: **NC26AC**
13" diameter x 26" tall, 110 GPH pump
with 10' power cord

Part #	Description	Stocking Code	Ship Weight	List Price
NCC250	Canyon Creek Self Contained Waterfall w/pump	3181997	78 lbs.	\$259.99
BHS30	Bronze Heron Fountain (purchase pump separately)	176991	20 lbs.	\$109.99
NCH45	Hampton Tiered Fountain w/pump	9230992	70 lbs.	\$329.99
NCH48	Harmony Tiered Fountain w/pump	5244994	132 lbs.	\$349.99
NC26AC	Self Contained Cracked Vase Fountain w/pump	6139993	20 lbs.	\$199.99
NCL21	Self Contained Log Falls w/pump	2139995	60 lbs.	\$199.99



RBH26

RETAIL FRIENDLY

Redi-Basins

- Strong HDPE molded tubs
- RBH21 includes center support under lid for heavy loads
- Stackable for reduced shipping costs

Great Prices!

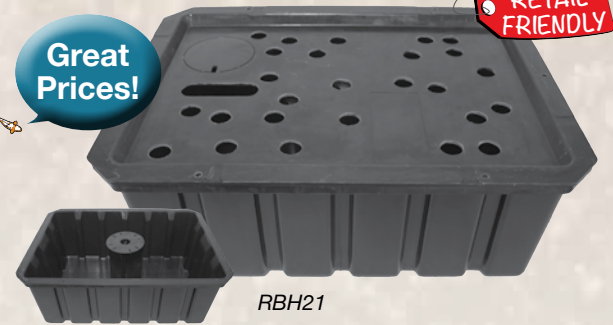

RBH21

RETAIL FRIENDLY

Part #	Description	Capacity	Height	Stocking Code	Ship Weight	List Price
RBH21	Rectangle basin 21" x 28"	17 gallons	10 ¹ / ₄ "	3104997	13 lbs.	\$149.99
RBH26	Round basin 26" diameter x 14 ¹ / ₄ " tall	20 gallons	14 ¹ / ₄ "	9104991	11 lbs.	\$149.99

Self Contained Basin

Great for making custom, self-contained fountains. Made with alternative concrete material that is fiber reinforced for strength.

- For above ground use
- 23" diameter x 8" tall
- Fountain not included



NEW

RETAIL FRIENDLY

Déco-Crete

Part #	Stocking Code	Ship Weight	List Price
RBC23	5104991	60 lb.	\$149.99

Polished Stone

- Available in 20 pound bags
- Two per case
- Decorative cover for basin lids (above)

NEW

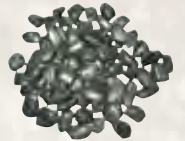

Part #	Stocking Code	Ship Weight	List Price
TDR20	311198	21 lb.	\$15.99

LED Statuary Light Set

- 1³/₈" diameter
- cUL listed
- 12 per case
- Barbed inlet fitting for use with 3/4" tubing
- Designed for use with most Tranquil Décor fountains
- 10' power cord between light and transformer, 6' power cord on transformer



SAVE 5% ON A CASE!

Part #	Description	Stocking Code	Ship Weight	List Price
LED8B	LED Light & Transformer	324498	2 lbs.	\$34.99
LED8B3	3 LED Lights & Transformer	645491	3 lbs.	\$64.99

AQUASIS™ PUMPS Statuary Pumps



- Oil free, fish safe design
- Adjustable flow control
- Clamshell packaged for retail sales
- UL listed

For more information see page 85

Statuary Splitter

- 1/2" and 3/4" stepped barb fittings on inlet and outlet
- Individual flow control valve on each line



Part #	Case Quantity	Stocking Code	Ship Weight	List Price
TWS3	12	39727	1 lb.	\$13.89

Plumbing Kits for Basalts

- Connect pump to basalt columns
- Includes friction ring to hold tubing inside basalt
- PK3L includes splitter, three pieces of 3/4" tubing and three friction rings

Part #	Stocking Code	Ship Weight	List Price
PK1L Single	56996	1 lb.	\$9.99
PK3L Triple	927993	1 lb.	\$39.99

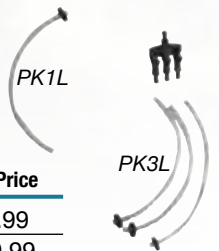



OFS7A - BASALT
8" x 9" at base, 20" tall
OFS7B - BASALT
6" x 7" at base, 30" tall
OFS7C - BASALT
10" x 11" at base, 40" tall
OFS7D (NOT PICTURED)
9" x 11" at base, 60" tall



These statuary pieces offer a variety of fountain options. Molded from tough, impact resistant, UV protected resin — these pieces look very realistic! All pieces have a 3' piece of vinyl tubing included with statue for easy pump connection.



Use for outdoor or indoor display!



OFS12 - SPLIT FACE
19" diameter, 16" tall

OFS16 - STACKED SLATE
14" diameter at top, 23" tall

Part #	Description	Inlet Tubing	Recommended Flow Rate	Recommended Basin	Stocking Code	Ship Weight	List Price
OFS7A	Basalt Rock, Fiberglass	3/4"	200 GPH	RBH26, EFB26, FB28E	359349	5 lbs.	\$91.29
OFS7B	Basalt Rock, Fiberglass	3/4"	200 GPH	RBH26, EFB26, FB28E	188787	7 lbs.	\$136.59
OFS7C	Basalt Rock, Fiberglass	3/4"	200 GPH	FBL40	2126612	9 lbs.	\$194.79
OFS7D	Basalt Rock, Fiberglass	3/4"	200 GPH	EFB50	5216648	24 lbs.	\$333.29
OFS12	Split Face Column	3/4"	400 GPH	RBH26, EFB26, FB28E	158303	25 lbs.	\$89.69
OFS16	Stacked Slate Bubbler	3/4"	400-600 GPH	RBH26, EFB26, FB28E	273968	24 lbs.	\$113.79
SFK12N	Resin Basalt Kit: includes FBL48 Basin, EP1050 Pump, OFS7A, B & C Statuary				6551578	93 lbs.	\$847.49
SFK15N*	Slate Vase Kit: includes: RBH26 Basin, EP400 Pump, OFS16 Statuary				5201275	24 + 15 lbs.	\$299.59
SFK16N	Split Vase Kit: includes: RBH26 Basin, EP400 Pump, OFS12 Statuary				3188191	25 + 15 lbs.	\$279.49

Kits include the necessary fittings for assembly and operation



Japanese Lanterns

These resin lanterns are very realistic and make a beautiful addition to the landscape around koi ponds and water features.

JLB11 — Brown resin lantern, 11" diameter x 17" tall
JLW11 — White resin lantern, 10 1/2" diameter x 19" tall



Part #	Description	Case Quantity	Stocking Code	Ship Weight	List Price
JLB11	Brown Lantern	4	355508	10 lbs.	\$85.39
JLW11	White Lantern	4	755503	10 lbs.	\$85.39

For decorative purposes only!

Statuary Splitters

Ideal for operating multiple pieces of statuary off a single pump

SS4 SPLITTER

- Connect end to end to make 8, 12, 16, etc. manifolds
- Can handle up to 1200 GPH flow, higher flows use SS10
- Can be used with water or air pumps

SS10 SPLITTER

- A larger splitter, for use in large air and water pumps
- Use with standard nylon male adapters found on page 108
- 1" threads on main body with 3/4" female threaded outlets on valves



Part #	Size	Stocking Code	Ship Weight	List Price
SS4	3/4" Statuary Splitter with 1/2" Valves	128537	1 lb.	\$43.89
SS10	1" Statuary Splitter with 3/4" Valves	520274	2 lbs.	\$31.19
Specialty fittings for SS4 outlet to statuary tubing:				
SS41238	1/2" fpt x 3/8" barb	72572	1 lb.	\$3.67
SS41212	1/2" fpt x 1/2" barb	31828	1 lb.	\$2.60
SS41234	1/2" fpt x 3/4" barb	42187	1 lb.	\$3.12

Black Waterfall Foam

Use to fill in cracks between rocks to prevent water from being “lost” over the waterfall

- Improves water flow visually and black color hides foam in the shadows of the rocks
- Hand foam cans have a patented trigger system which allows multiple uses
- Trigger will dispense foam in any position
- Fish safe, non toxic formula
- **BWFN** is minimal expanding foam — fills in cracks with less trimming of excess foam
- 29 ounce gun foam also available for high volume users, use with foam guns (below), cleaner should be used any time the can is removed and left off — this will remove any uncured foam from inside the gun



Aquatic Rock (MN)

Part #	Description	Case Quantity	Stocking Code	Ship Weight	List Price
BWFN	20 ounce Hand Held Foam	12	416306	2 lbs.	\$23.29
BGF	29 ounce Gun Foam	12	534120	3 lbs.	\$52.49
GFC	Gun Foam Cleaner	12	215338	2 lbs.	\$23.59

Professional Foam Gun

Designed to withstand years of use

This all steel, professional foam gun comes with complete instructions and a wrench for disassembly. This gun is well worth the money!

Part #	Stocking Code	Ship Weight	List Price
FSG	3113872	3 lbs.	\$175.19



Silicone Sealant

Ideal for all types of uses when a water tight seal is needed

- Great for attaching faceplates to skimmers and stone lips to the AquaFalls filters
- Sold in a 2.8 ounce squeeze tube for easy application (no caulk gun needed)

Part #	Case Quantity	Stocking Code	Ship Weight	List Price
SCT1	12	36296	1 lb.	\$8.99



Waterfall Installation Kit

A combination of the most common items needed to install ponds and waterfalls

- Includes one can black foam, one tube silicone, one can glue, one can primer and one 6" diameter liner patch
- **WIK2** has two tubes of silicone and larger size can of glue for installing large pond kits

Part #	Stocking Code	Ship Weight	List Price
WIK	339716	3 lbs.	\$61.09
WIK2	745953	4 lbs.	\$70.69





These box style valves replace water lost due to evaporation or small leaks in ponds and Just-A-Falls systems. Mount inside skimmer or in our water fill box!

Water Fill Valves

BRASS FILL VALVES

- Ideal for use in skimmers, vaults and the water fill box (below) for maintaining water levels in many different applications
- Heavy duty brass body and brass rods are far superior to normal plastic fill valves
- All valve rods (arms) can be adjusted to fit your exact requirements
- WFS37, WFS50, WFS100 and WFS150N come with plastic float
- Recommended water pressure: 35 psi

“BOX STYLE” FILL VALVE

This durable fill valve is ideal since the float is contained inside the valve box. No chance of damaging unit when lifting pumps in or out of skimmer.

- Delivers up to 245 GPH at maximum of 55 PSI
- Includes fitting to connect to 1/2" vinyl tubing
- Fits in small or large skimmer
- Measures 7 1/2" long x 3" wide x 4" high

Part #	Description	Overall Length	GPM Flow at PSI:			Stocking Code	Ship Weight	List Price
			15	35	55			
BFS	1/2" Box Style Fill Valve	7 1/2"	6	5	4	630614	2 lbs.	\$47.09
WFS37	1/2" Economy Brass Valve	8"	11	16	19	431063	2 lbs.	\$47.79
WFS50	1/2" Brass Fill Valve	12 1/2"	12 1/2	17 1/2	21	746216	2 lbs.	\$71.09
WFS100	1" Brass Fill Valve	17"	38	64	70	364738	3 lbs.	\$99.59
WFS150N	1 1/2" Brass Fill Valve w/plastic float	19 1/2"	90	129	158	6141822	5 lbs.	\$218.19



Part #	Size	Stocking Code	Ship Weight	List Price
WFB	15" long x 8" x 8"	855503	4 lbs.	\$85.39

A water fill box makes an ideal spot for auto-fills in Just-A-Falls type features

Water Fill Box



Ideal for auto fills inside ponds, Just-A-Falls systems or formal pools!

- A good way to mount a water fill valve in a pond without a skimmer
- Provides an ideal housing in which to install an auto fill
- Sits inside the liner and holds fill valves up to 13" long
- 1" overflow is included for exact water heights
- Auto fill valve sold separately



Sinacori Landscape (MI)



PRO SERIES

CHECK VALVE ASSEMBLIES

Check valve assemblies connect the pump to the plumbing and keep plumbing line full of water even when the pump is off. Pre-assembled check valves are sized to properly fit a pump and equipment combination to desired pipe size. Use the chart below to select proper check valve assembly.

Part #	Size	Compatible Pump Models	Fits	Stocking Code	Ship Weight	List Price
CVA12EP	1 1/4"	EP2200	PSM	331457	2 lbs.	\$48.39
CVA12TG	1 1/4"	TS150/TS250	PSM	731329	2 lbs.	\$48.19
CVA15EP	1 1/2"	EP2200/EP3200	PSM	633408	2 lbs.	\$51.39
CVA15TGM	1 1/2"	TS150/TS250/TS400	PSM	532433	2 lbs.	\$49.89
CVA15THM	1 1/2"	TH150	PSM	133990	2 lbs.	\$52.29
CVA15TG	1 1/2"	TS150/TS250/TS400	PSA5000/7000/PS1/JAFM/PV60E	832436	2 lbs.	\$49.89
CVA15TH	1 1/2"	TH150/TH250/TH400/TH750	PSA5000/7000/PS1/JAFM/PV60E	433995	4 lbs.	\$52.29
CVA20TH	2"	TH150/TH250/TH400/TH750	PSA5000/7000/PS1/JAFM/PV60E	547444	4 lbs.	\$72.99
CVA30EP9	2" x 3"	EP9700	PS2/JAFV	583841	8 lbs.	\$128.99
CVA30EP2	3"	All TM/TB/WQ Pumps	PS2/JAFV	991777	9 lbs.	\$141.19
CVA30K9*	2" x 3"	EP9700	PSA9000/11000	693330	10 lbs.	\$143.59
CVA30K*	3"	TB8000/TM9500/TB12000**/TM13500**	PSA9000/11000	390418	10 lbs.	\$139.09



*Assembly is cut to length on-site and male adapter glued on, check valve installs outside skimmer

**These pumps can be used only in applications where the operating head pressure reduces flow under 11000 gph (skimmer capacity)

ECO-Series® CHECK VALVE ASSEMBLIES

Part #	Size	Compatible Pump Models	Fits	Stocking Code	Ship Weight	List Price
SCVA1217	1 1/4"	EP1750	PS4E	231846	2 lbs.	\$48.99
SCVA12PS	1 1/4"	EP850, EP1050, EP1350	PS4E	631842	2 lbs.	\$48.99
SCVA12MS	1 1/4"	EP2200, EP3200	PS6E	731842	2 lbs.	\$48.99
SCVA12TG	1 1/4"	TS150, TS250, TS400	PS6E	132300	2 lbs.	\$49.69
SCVA15MS	1 1/2"	EP2200, EP3200	PS6E	232496	2 lbs.	\$49.99
SCVA15TG	1 1/2"	TS150, TS250, TS400	PS6E	333408	2 lbs.	\$51.39
SCVA15PV	1 1/2"	EP2200, EP3200	PV60E, JAFM, PS1	532493	2 lbs.	\$49.99
SCVA20MS	2"	TH150, TH250, TH400	PS6E	941721	4 lbs.	\$64.19
SCVA20PS	2"	EP4700, EP6700	PS6E	843749	4 lbs.	\$67.29
SCVA2047V	2"	EP4700, EP6700	PV60E, JAFM, PS1	341078	4 lbs.	\$63.19
SCVA20TE	2"	TH400, TH750	PS10E	243158	5 lbs.	\$66.39
SCVA2067	2"	EP6700	PS10E	946661	5 lbs.	\$71.79
SCVA2097	2" x 3"	EP9700	PS10E	449657	6 lbs.	\$76.39
SCVA30PS	3"	TB8000	PS10E	383585	9 lbs.	\$128.59

PUMP OUTLET ASSEMBLIES

In many applications a check valve is not needed on the pump outlet. Especially on small Just-A-Falls kits. These assemblies are designed for use on pumps used inside EasyPro pump vaults.



Part #	Size	Compatible Pump Models	Fits	Stocking Code	Ship Weight	List Price
PDA12MD	1 1/4"	EP1350, EP1750	JAFT	319621	1 lb.	\$30.19
PDA12EP	1 1/4"	EP2200	JAFT	220793	1 lb.	\$31.99
PDA12TG	1 1/4"	TS150, TS250	JAFT	820534	1 lb.	\$31.59
PDA125	1 1/2"	EP2200, EP3200	JAFT	623000	1 lb.	\$35.39
PDA155	1 1/2"	TS150, TS250	JAFT	220085	1 lb.	\$30.89
PDA15EP	1 1/2"	EP2200, EP3200	PV60E, JAFM	722167	1 lb.	\$34.09
PDA15TG	1 1/2"	TS150, TS250, TS400	PV60E, JAFM	120089	1 lb.	\$30.89
PDA20EP	2"	EP4700, EP6700	PV60E, JAFM	821834	1 lb.	\$33.59
PDA20TH	2"	TH150, TH250, TH400, TH750	PV60E, JAFM	925542	2 lbs.	\$39.29
PDA3097	2" x 3"	EP9700	JAFV	141146	3 lbs.	\$63.29
PDA3016	3"	All TM, TB, WQ pumps	JAFV	442579	5 lbs.	\$65.49



Underwater Lighting



EasyPro offers one of the largest selections in underwater lighting of anyone in the country. From the industry standard 20 watt halogen lights to low voltage LEDs to fiber optic systems, we have a lighting solution for nearly every application.

LED20 Light Rings
Installed by Pond Professional (GA)

Underwater LED Lights



LED4WW

3 WATT LED LIGHT

- Cast aluminum housing and removable base
- 15' power cord
- Light dimension: 3" tall x 1 5/8" diameter
- Equivalent of 20 watt halogen bulb



LED6WP

6 WATT LED LIGHT

- 30' power cord
- Includes four colored lens
- Bulb life rated for 80,000 hours
- Equivalent of 35-50 watt halogen bulb



LED6WS

6 WATT STAINLESS LED LIGHT

- 30' power cord
- Bulb life rated for 80,000 hours
- Equivalent of 35-50 watt halogen bulb
- Durable stainless steel fixture

Part #	Description	Warranty	Stocking Code	Ship Weight	List Price
LED4WW	3 watt aluminum, Warm White LED light	2 years	258169	2 lbs.	\$83.09
LED4WWK	(2) LED4WW lights above with EPT45 transformer	2 years	6150495	3 lbs.	\$214.99
LED6WP	6 watt plastic, Warm White LED light	3 years*	779796	3 lbs.	\$113.99
LED6WPK	(2) LED6WP lights above with EPT45 transformer	3 years*	9195997	4 lbs.	\$279.99
LED6WS	6 watt stainless steel, Warm White LED light	5 years*	5131662	5 lbs.	\$188.09

*LED bulb has 2 year warranty



LED2W

EXTRA BRIGHT MINI LED LIGHTS

- Low voltage lights are smaller than a golf ball and yet have an incredibly bright output
- The small light fixture is rock shaped which makes hiding them easy
- Sold in packs of two (LED2W) or in a kit (LED2K) with three lights and MT10 transformer with 15' power cord



LED20

LED LIGHT RING

- This submersible LED light ring can be used to light up bubbling statuary, small fountains or used in/out of water to light waterfalls
- 20 low voltage LED bulbs encased in ring for maximum brightness
- 2" O.D., 1 1/8" I.D. with 30' power cord

Part #	Description	Size W x H x D	Warranty	Case Quantity	Stocking Code	Ship Weight	List Price
LED2W	16 Diode Light, 2 pk., Cool White	1 1/2" dia	1 year	6	749691	2 lbs.	\$70.99
LED2K	3 pk. LED2W lights above with MT10 transformer	-	1 year	4	283990	4 lbs.	\$119.99
LED20	20 Diode Light Ring, Cool White	2" dia x 3/4" thick	1 year	6	138008	2 lbs.	\$54.29

LED2W and LED20 lights come with quick plug cord ends for easy connection to MT10, MT20, MT60 or EPT45 transformers on page 46.



Underwater LED Light Strips



- Ideal for use with Vianti Falls on page 18, waterfall diffusers on page 17 or underwater to light up waterfalls, streams, etc.
- 15' power cord between light and transformer
- Available in 11", 23" or 35" lengths
- Includes MT10 transformer
- Use in or out of water

Alta Falls (MN)



Bogert Products (MN)

Part #	Description	Warranty	Stocking Code	Ship Weight	List Price
LED11WW	11" LED Light Strip, Warm White	3 years	260899	3 lbs.	\$86.99
LED11CB	11" LED Light Strip, Blue	3 years	860894	3 lbs.	\$86.99
LED23WW	23" LED Light Strip, Warm White	3 years	9101490	4 lbs.	\$144.99
LED23CB	23" LED Light Strip, Blue	3 years	3101496	4 lbs.	\$144.99
LED35WW	35" LED Light Strip, Warm White	3 years	1139998	5 lbs.	\$199.99
LED35CB	35" LED Light Strip, Blue	3 years	7139992	5 lbs.	\$199.99

Industrial Grade LED Lights

These compact, underwater LED lights are the brightest, best quality lights available

- Permanently sealed, epoxy filled light housings are virtually indestructible
- 80,000 hour bulb rating



LED3W



LED124B

LED48B

SAVE 5% ON A CASE!

RETAIL FRIENDLY

48 DIODE 3 PACK LED LIGHTS

- Wired "daisy chain" style with 15' power cord to first light, 6' power cords between first, second and third light with quick attach ends for easy, tool free installation
- Available in three pack or in a kit with three lights and EPT45 transformer

Part #	Description	Size W x H x D	Warranty	Case Quantity	Stocking Code	Ship Weight	List Price
LED3W	48 Diode, 3 pk. Daisy Chain, Cool White	2 ³ / ₄ " dia	3 year	6	5106119	4 lbs.	\$151.59
LED3K	LED3W Lights & EPT45 kit (three lights included in kit)	-	3 year	4	3146996	7 lbs.	\$209.99
LED48W	48 Diode Light, Cool White	4" dia	3 year	6	449201	2 lbs.	\$70.29
LED48B	48 Diode Light, Blue	4" dia	3 year	6	249207	2 lbs.	\$70.29
LED48WK	Two LED48W Lights & EPT45 transformer kit	-	3 year	4	5132995	5 lbs.	\$189.99
LED124W	124 Diode Light, Cool White	5" dia	3 year	6	696738	4 lbs.	\$138.19
LED124B	124 Diode Light, Blue	5" dia	3 year	6	196733	4 lbs.	\$138.19

*Kit includes three individual lights (not three double packages)

48 & 124 DIODE LED LIGHTS

- Quick attach ends for easy, tool free installation
- Available in white or blue low voltage LED lights
- Available individually or as a kit with two LED48W lights and EPT45 transformer
- 15' power cord

Underwater LED Solar Lights



SOL3P

SOL1

- The brightest solar light we have ever seen! Light up flag poles (we tested on 20' pole - easily illuminated all the way to the top), signs, waterfalls, up-light trees, etc. 20' power cord, battery and mounting stake for solar panel included

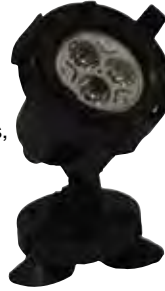

SOL1

SOL3P

- Three pack of solar lights with 15' cord to first light, 3' cord to second and third lights (daisy chained together), battery and mounting stake for solar panel included

Both LED solar units last seven to eight hours on a fully charged battery and have a photocell in solar panel to turn lights on at dark

Part #	Description	Stocking Code	Ship Weight	List Price
SOL1	Solar Light, High Intensity	6139990	5 lbs.	\$199.99
SOL3P	Solar Lights, 3 pack	390998	4 lbs.	\$129.99

LED & Halogen Bulbs



LED11W Cool white LED bulb for MRL10



EPL75B Halogen replacement bulb for EPL75



LED6B Warm white LED bulb for EPL20 and EPSL



SLKB20/35/50 Halogen replacement bulbs



MRLB Halogen replacement bulb for MRL10

Part #	Description/Watts	Fits	Stocking Code	Ship Weight	List Price
LED6B	Warm White LED Bulb - 6 watts	EPL20, EPSL	132753	1 lb.	\$46.79
LED11W	Cool White LED Bulb - 1.8 watts	MRL10	419318	1 lb.	\$27.59
LED16W	Cool White LED Bulb - 3.6 watts	EPL20, RL20, EPSL	919247	1 lb.	\$27.49
LEDB	Color Changing LED, MR16 Base	EPL20, RL20, EPSL	529049	1 lb.	\$41.49
MRLB	Halogen Bulb - 10w	MRL10	14541	1 lb.	\$6.49
SLKB20	Halogen Bulb - 20w	EPL20, RL20, EPSL	84893	1 lb.	\$6.99
SLKB35	Halogen Bulb - 35w	EPL20, RL20, EPSL	65315	1 lb.	\$7.59
SLKB50	Halogen Bulb - 50w	EPL20, EPSL	45597	1 lb.	\$7.99
EPL75B	Halogen Bulb - 75w	EPL75	26019	1 lb.	\$8.59

Parts for Underwater Lights



LEDEX - 15' extension cable for use with LED lights, extend distances between LED light fixtures from one transformer (see drawing below)

Part #	Description/Watts	Fits	Stocking Code	Ship Weight	List Price
EPL20 "O"	O-Ring Gasket	EPL20/RL20	23705	1 lb.	\$5.29
MRL10 "O"	O-Ring Gasket	MRL10	63121	1 lb.	\$4.79
EPL75 "O"	O-Ring Gasket	EPL75	310008	1 lb.	\$14.29
EPSL "O"	O-Ring Gasket	EPSL	94404	1 lb.	\$6.29
EPL20L	Clear Replacement Lens	EPL20/RL20	45879	1 lb.	\$8.39
MRL10L	Clear Replacement Lens	MRL10	85103	1 lb.	\$7.29
EPL75L	Clear Replacement Lens	EPL75	118756	1 lb.	\$26.79
EPSLL	Clear Replacement Lens	EPSL	56782	1 lb.	\$9.69
EPL20RC	Retainer Cap for Lens	EPL20	73357	1 lb.	\$4.79
LEDEX	15' Extension Cable for use with LED lights		314347	1 lb.	\$20.49
L3WS	Three Way LED Splitter		58745	1 lb.	\$12.49

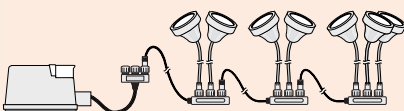

EPL20L Replacement lens for EPL20 & RL20 lights



L3WS Three way splitter for use with underwater lights



O-ring gaskets

Underwater Halogen Lights



SAVE 5% ON A CASE!

20 WATT SUBMERSIBLE LIGHTS

- Light housing is epoxy filled at the bottom where the cord enters
- Includes four colored lens
- Can be used with or without mounting base

75 WATT LIGHT

- 75 watt halogen light with a large diameter lens for maximum lighting
- 5" diameter lens provides large coverage area
- Includes four colored lens
- Use as submersible light only



SUBMERSIBLE ROCK LIGHTS

- Available in 10 and 20 watt sizes
- Simulated rock shell makes these lights very easy to hide in ponds, streams and waterfalls!
- Includes four colored lens (shown above)

35 WATT STAINLESS STEEL LIGHT

If you are looking for a heavy duty light — look no further!

- Built for "severe duty" applications
- Can be used submerged or out of water — ideal for architectural pools and fountains
- 20 and 50 watt bulbs can also be used

Part #	Description	Watts	Power Cord	Size L x W x H	Lens Included	Limited Warranty	Case Quantity	Stocking Code	Ship Weight	List Price
EPL20	20 watt Light with Lens	20w	30'	2 1/2" x 2 1/2" x 3 1/2"	4 color	3 year	6	353191	2 lbs.	\$75.99
MRL10	10 watt Rock Light	10w	20'	3 1/2" x 3" x 3"	4 color	1 year	6	943532	1 lb.	\$62.19
RL20	20 watt Rock Light	20w	30'	6" x 4 1/2" x 3 1/2"	4 color	3 year	6	160897	3 lb.	\$86.99
EPL75	75 watt Light	75w	30'	5 1/2" x 5 1/2" x 5"	4 color	3 year	4	765231	4 lbs.	\$93.19
EPSL	35 watt Stainless Light	35w	30'	4" x 4" x 5 1/2"	1 clear	5 year	6	8108774	5 lbs.	\$155.39

Lighting Kits

Halogen

MRK3

Three pack of MRL10 rock lights with MT60 transformer



EPLK2

Two pack of EPL20 lights with one EPT100 transformer



Part #	Description	Limited Warranty	Case Quantity	Stocking Code	Ship Weight	List Price
MRK3	3-10w Halogen Lights w/MT60	1 year	4	6148603	8 lbs.	\$212.29
EPLK2	2-20w Halogen Lights w/EPT100	3 year	4	2135655	12 lbs.	\$193.79

Low voltage transformers on page 46 • Replacement parts and bulbs on page 42

Color Changing LED Light

This bulb allows for multiple colored lights, similar to fiber optic, in a single 12 volt fixture

- EPL20 submersible light fixture has 30' power cord
- Light slowly rotates through a white, green, white, red, white, blue, white, amber cycle - providing a slow, subtle changing lighting affect
- Bulb also available separately as replacement in existing lights (see **LEDB** on page 42)



Part #	Description	Stocking Code	Ship Weight	List Price
LED4CP	EPL20 Fixture with Color LED Bulb	379798	3 lbs.	\$113.99
LEDB	Color Changing Bulb Only, 12 volt	729046	1 lb.	\$41.49

Fiber Optic Lighting

Fiber optic lighting is much different than normal low voltage lighting. Fiber optic lighting has a shore mounted illuminator box which has the light bulb inside it. The light shines through a rotating color wheel, as it rotates the light changes color. The light is then carried down the fiber optic cables into the water. This means that there is no power in the water and when it's time to change a light bulb it is easy to do since the bulb is on shore in the illuminator box, not underwater! Up to 18 fiber optic cables can be run off of one light bulb in the deluxe illuminator box and each fiber cable can be up to 80' long.

EasyPro deluxe fiber optic systems have several advantages over similar brands:

Much Smaller —

Advanced technology allows our illuminators to be much smaller than our competitors, making them easier to hide.

More Colors —

EasyPro kits have eight different colors built in!

Longer Cables —

Our standard packages have longer cables between the light source and the actual lights.

Lower Price —

Superior design and engineering allows us to offer a superior product for less money!

Compare the features and price, these systems are superior to any other on the market!



Landscape Design (MI)

Solid Light Cable

By using solid core cable we can also offer a cable without the jacket around it. This allows light to shine down the entire length of the cable instead of just at the end. Great for use around pools and architectural fountains. See custom kits on the next page for cable pricing. Solid and regular light cables can be mixed on same illuminator. Call for maximum length.



EasyPro Pond Products (MI)

A continuous solid light cable and eight solid core light cables were used together on this formal installation

ENTRY LEVEL SYSTEMS

This system uses the same highest quality solid core fiber cable as the deluxe set to provide excellent lighting in smaller settings. It will run up to six fiber cables.

- 100 watt halogen light bulb
- Powder coated, weather resistant cabinet
- Cooling fan inside cabinet prevents overheating
- Eight color wheel — rotates slowly between colors or can be stopped on any color
- Stainless ends on fiber cables protect cable from damage
- Available in four light or six light packages with precut cable lengths — or custom order kits using EFOI illuminator and up to six cables (maximum length 40')



One Year Warranty

Part #	Description	Warranty	Cable Lengths	Stocking Code	Ship Weight	List Price
EFO41	4 Light Kit, 100 watt	1 year	two-12', two-16'	7642043	8 + 11 lbs.	\$889.79
EFO42	4 Light Kit, 100 watt	1 year	two-15', two-25'	4765756	10 + 11 lbs.	\$1054.69
EFO61	6 Light Kit, 100 watt	1 year	two-12', two-16', two-22'	8879372	12 + 11 lbs.	\$1207.19
EFO62	6 Light Kit, 100 watt	1 year	three-16', three-26'	51013390	13 + 11 lbs.	\$1385.89

DELUXE FIBER OPTIC SYSTEMS

These premium lighting packages are loaded with features! Up to 18 light cables can be run off one illuminator. These kits can be custom built to your specifications (see below).

- 150 watt metal halide bulbs — 6,000 to 9,000 hour life!
- Eight color wheel — rotates slowly between colors or can be stopped on any color
- Stainless steel, lockable, weatherproof cabinet
- Circuit upgrade option — allows user to create light shows by selecting only certain colors of the light wheel and allows user to adjust the speed of the color wheel rotation
- Remote control option — allows user to turn lights on and off from up to 60' away!



Three Year Warranty

Part #	Description	Warranty	Cable Lengths	Stocking Code	Ship Weight	List Price
FOL6	6 Light Kit	3 years	w/2-14', 2-16' & 2-18' cables	71352341	27 + 8 lbs.	\$1807.89
FOL8	8 Light Kit	3 years	w/2-12', 2-14' & 4-22' cables	31582023	27 + 10 lbs.	\$2115.09
FOL12	12 Light Kit	3 years	w/2-12', 4-14', 2-20', 2-22', & 2-25' cables	61927729	27 + 12 lbs.	\$2577.89
FOL16	16 Light Kit	3 years	w/6-16', 2-22', 4-24', & 4-32' cables	82587937	27 + 14 lbs.	\$3459.69

CUSTOM BUILT FIBER OPTIC SETS:

We can customize the number of lights from four to 18 and the cable length of each light from a minimum of 10' to a maximum of 80'! To calculate your cost add up total length of cable runs and multiply by cost per foot of cable. Add cable cost to illuminator cost to equal package price.



Part #	Description	Stocking Code	Ship Weight	List Price
EFOI	Standard Illuminator - up to 6 Cables, 40' max. length each	9335782	11 lbs.	\$479.69
FOI*	Deluxe Illuminator - up to 18 Cables, 80' max. length each	3914998	27 lbs.	\$1219.99
FOIU*	Deluxe Illuminator with DMX control upgrade, 18 cables, 80' max.	21241479	27 lbs.	\$1655.29
FOC5	Solid Core Cable (new larger diameter), per foot	75549	—	\$7.39
FOLS	Solid Light Cable, per foot	65090	—	\$6.79
FOLRC*	Remote Control - FOI Illuminator Only	356621	1 lb.	\$75.49
FOLB	Metal Halide Bulb - 150w for FOI	798926	1 lb.	\$131.89
EFOB	Halogen Bulb - 100w for EFOI	241991	1 lb.	\$59.99

*Deluxe illuminator box can hold **either** remote control option **or** circuit upgrade option (not both), neither option can be used with standard box.

Custom built fiber optic sets typically ship within 2 - 3 business days!

Low Voltage Transformers

SAVE 5% ON A CASE!

10 WATT TRANSFORMER

- Three outlet strip is ideal for use with LED lights
- Transformer plugs directly into outlet

Use LEDEX to extend lengths and add more LED lights, page 42



20 & 60 WATT TRANSFORMERS

- Six outlet strip makes connecting multiple lights easy!
- Great for use with low wattage LED lights
- Use with EPT14 for automatic photo eye operation

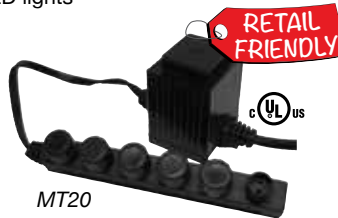

45 WATT TRANSFORMER WITH PHOTO EYE

- Photo eye for automatic on at dusk with four, six or eight hour settings
- Includes screw type connectors for halogen lights and three way splitter for LED lights



100/150 WATT TRANSFORMERS WITH PHOTO EYE

- Has a photo eye that automatically turns on at dusk and a timer that runs four, six or eight hours before turning lights off
- Epoxy filled and weatherproof for long life
- Capable of 100% loads
- 150w model also available in 230v



300W, MULTI-TAP TRANSFORMER

- Photo eye built in for automatic on/off
- Push button settings keep lights on for one to nine hours - or can be set to run dusk till dawn
- Multiple voltage connections on back
- Ideal for long line runs: 12v, 13v, 14v, or 15v connections



600 WATT TRANSFORMERS

- Features a photo eye for automatic on/off
- Easy push button settings keep lights on from one to nine hours after turning on - or can be set to run dusk till dawn



Part #	Watts	Power Cord	Size W x D x H	Photo Eye Included	Limited Warranty	Case Quantity	Stocking Code	Ship Weight	List Price
MT10	10w	—	1 7/8" x 1 5/8" x 3 1/4"	no	3 years	6	116584	1 lb.	\$23.69
MT20	20w	2'	2" x 2" x 2 1/2"	no	3 years	6	631493	2 lbs.	\$44.99
MT60	60w	2'	3" x 2 1/2" x 3"	no	3 years	6	837583	3 lbs.	\$53.69
EPT45	45w	6'	3 1/2" x 5" x 2 1/2"	yes	3 years	6	343539	5 lbs.	\$62.19
EPT100	100w	17"	4" x 6" x 3 1/2"	yes	3 years	4	269221	8 lbs.	\$98.89
EPT150	150w	17"	4" x 6" x 3 1/2"	yes	3 years	4	486020	9 lbs.	\$122.89
EPT1502	150w	17"	4" x 6" x 3 1/2"	yes	3 years	4	484067	9 lbs.	\$120.09
EPT300T	300w	17"	5" x 10 1/2" x 5"	yes	3 years	2	6145108	18 lbs.	\$207.29
EPT600	600w	24"	9" x 10 1/2" x 5"	yes	3 years	2	4285036	29 lbs.	\$407.19



Timer with Photo Eye

- Automatically turns on at dusk and can be programmed to stay on for one to nine hours after dark or from dusk to dawn
- Dual 115v plugs allow multiple items to be controlled with single timer
- Weather proof design for use outdoors
- 1000 watt maximum load



SAVE 5% ON A CASE!

Part #	Description	Case Quantity	Stocking Code	Ship Weight	List Price
EPT19	Outdoor timer with photo eye	6	321552	3 lbs.	\$30.79

Multi-Vent Underliner System

Multi-Vent Underliner System is a patented, innovative and cost effective system designed to protect pond and lagoon liners from damage caused by methane gas and water accumulation.

Multi-Vent is a series of perforated tubes that install under the liner. The tubes are wrapped in a non-woven geo-textile to prevent plugging. By simply laying a strip of Multi-Vent on the ground before installing the liner you can prevent costly future problems.

With Multi-Vent, neither water nor air can build up pressure under the liner. Multi-Vent is cheap insurance under any liner job!!



*MV6100 can be shipped UPS but dimensional rates will apply



Typical multi-vent layout

Part #	Description	Stocking Code	Ship Weight	List Price
MV6100*	Multi-Vent, 100' Roll	4191919	34 lbs.	\$239.89
MV625	Multi-Vent, 25' Roll	748556	10 lbs.	\$60.69
MV6F	Multi-Vent, per foot	82155	—	\$2.69/foot
MV6C	Multi-Vent Coupling	311278	1 lb.	\$14.09
MV6E	Multi-Vent End Cap	95271	1 lb.	\$6.59
MV6Y	Multi-Vent "Y"	221993	1 lb.	\$27.49
MV6EO	Multi-Vent End Outlet to 3" Pipe	611274	1 lb.	\$14.09

Liner Air Vent



- Use these 1 1/2" vents to release air or water trapped under pond liners
- Includes 1 1/2" bulkhead fitting and pressure relief fitting
- Helps prevent liner from floating up when air (or water) gets trapped underneath

Part #	Description	Stocking Code	Ship Weight	List Price
LAV	Liner Air Vent	133443	1 lb.	\$44.59



Pond Shield

Ideal for sealing concrete ponds, pools and fountains

This nontoxic two part epoxy sealer is designed specifically for sealing concrete, steel, wood, fiberglass, etc. With Pond Shield you get all the water proofing of a liner without the wrinkles.

- Easy To Apply — No special equipment needed, just brush or roll on
- Flexible — Pond Shield remains flexible from -78° to 140°F
- Durable — Unlike other sealers, Pond Shield bonds to the substrate rather than just covering it, this leads to longer life with less repairs and maintenance
- Beautiful — Provides a smooth, hard finish with no wrinkles or folds — also makes surface easier to clean in the future

Part #	Description	Stocking Code	Ship Weight	List Price
PAQB	Black Pond Shield	362991	6 lbs.	\$89.99
PAQC	Clear Pond Shield	162993	6 lbs.	\$89.99
PAQCBL	Competition Blue Pond Shield	862997	6 lbs.	\$89.99
PAQG	Grey Pond Shield	662990	6 lbs.	\$89.99
PAQTN	Tan Pond Shield	562992	6 lbs.	\$89.99
PAQM	Copper Metallic Pond Shield	9139998	6 lbs.	\$199.99

1.5 quart kits are easy to ship. Can be special ordered in larger containers but due to hardening time smaller 1.5 quart batches are recommended.

Each kit covers approximately 60 square feet of surface area!



RETAIL FRIENDLY



Available in black, clear, competition blue, tan, grey and copper metallic





PondSeal™

Revolutionary way to seal leaking ponds, dikes, dams and spillways

SAVE 10% ON A PALLET!

- Sodium bentonite clay bonded to limestone aggregate creates a small rock-like “nugget” that sinks directly to pond bottom.
- Seals leaks without draining the pond
- Clay particles swell when wet, creating a solid layer of leak protection
- Great for sealing around intake pipes, muskrat holes, cuts and tears in liners
- Eco-friendly - all earthen ingredients, will not alter water chemistry
- Apply at five pounds per square foot for a 3/4" thick coverage or ten pounds per square foot for 1 1/2" thick coverage

MADE IN THE USA



Above picture shows how PondSeal pellets expand and gel into solid layer in water.



Great for sealing earthen dams and dikes!



PondSeal was used by Crystal Springs Trout Farm (MI) to seal this pond



Also available in bulk supersaks - 2,400 pounds per 3' x 3' x 3' bag. Please call for custom quotes on large jobs.

Can be used as a liner over entire pond or for spot sealing!

Part #	Description	Stocking Code	Ship Weight	List Price
SBC50	PondSeal, 50 lb. Bag	420018	53 lbs.	\$28.59
SBC250	PondSeal, 2400 lb. Supersak	1480053	2475 lbs.	\$685.79

Save 10% when you buy a full pallet (48 units) of 50 pound bags!

Pond Liner Underlayment

- Five ounce non-woven geo-textile fabric in three widths - 5', 10' and 15', easy to match up to the EPDM liner sold in 5' widths
- Provides additional tear and puncture protection from roots, stones or any other sharp objects
- Provides enhanced soil stability and erosion control
- Underlayment can be used on top of liner as well to protect from punctures when adding gravel
- Full rolls are 300' long

5', 10' & 15' Wide Rolls!

MADE IN THE USA



Contact us for special pricing on ten rolls or more.

Part #	Description	Stocking Code	Ship Weight	List Price
FPU	5', 10' or 15' wide x any length	1163	—	\$0.25/sq. ft.
FPUF5	5' wide x 300' roll	2201367	50 lbs.	\$309.79 roll
FPUF10	10' wide x 300' roll	4389345	105 lbs.	\$598.99 roll
FPUF15	15' wide x 300' roll	8564653	180 lbs.	\$868.69 roll

INTEGRA LINER™

30 mil EPDM Liner

Due to extreme price increases in 45-mil rubber liner, many customers are looking to other types of material such as PVC and HDPE for cost saving measures. Integra Liner allows you to retain this business by offering a high quality material with an unmatched 25 year warranty. EPDM rubber has long been the staple of the water feature industry. Offering this economical material will allow your customers to continue using the best product for their application instead of sacrificing quality by using an inferior product like PVC or HPDE. These materials are fine for use in other applications but for water features nothing can compare with the quality and benefits of EPDM liner.



Ideal For:

- Decorative ponds
- Pondless water features
- Rainwater containment systems
- Decorative fountains
- Koi ponds
- Erosion control management

Integra Liner is manufactured in Europe to the highest quality and standards in an ISO:9001 facility.



Cut to length

Any of the 10' through 30' wide rolls can be cut to your desired length in 1' increments. Make sure to specify width and length when ordering.



Part #	Description	Stocking Code	List Price
PL30	Specify width and length	8651	\$0.75

Boxed:

Part #	Size (sq. ft.)	Stocking Code	Ship Weight	List Price
PL30-1010 Boxed	10' x 10'	365001	17 lbs.	\$75.00
PL30-1015 Boxed	10' x 15'	997504	26 lbs.	\$112.50
PL30-1515 Boxed	15' x 15'	8146255	39 lbs.	\$168.75
PL30-1520 Boxed	15' x 20'	6195002	51 lbs.	\$225.00
PL30-2020 Boxed	20' x 20'	7260007	68 lbs.	\$300.00
PL30-2025 Boxed	20' x 25'	1325000	85 lbs.	\$375.00
PL30-2525 Boxed	25' x 25'	3406258	106 lbs.	\$468.75

Full Rolls:

Part #	Liner Size	Stocking Code	Ship Weight	List Price
PL3101 Roll	10' x 100'	6580009	170 lbs.	\$670.00
PL3151 Roll	15' x 100'	7870003	254 lbs.	\$1005.00
PL3201 Roll	20' x 100'	21160008	339 lbs.	\$1340.00
PL3251 Roll	25' x 100'	91450004	424 lbs.	\$1675.00
PL3301 Roll	30' x 100'	51740005	509 lbs.	\$2010.00

All liner rolls ship via motor freight

Poly Bags:

Part #	Size (sq. ft.)	Stocking Code	Ship Weight	List Price
PL30-1010BG Bagged	10' x 10'	365001	17 lbs.	\$75.00
PL30-1015BG Bagged	10' x 15'	997504	26 lbs.	\$112.50
PL30-1515BG Bagged	15' x 15'	8146255	39 lbs.	\$168.75
PL30-1520BG Bagged	15' x 20'	6195002	51 lbs.	\$225.00
PL30-2020BG Bagged	20' x 20'	7260007	68 lbs.	\$300.00
PL30-2025BG Bagged	20' x 25'	1325000	85 lbs.	\$375.00
PL30-2525BG Bagged	25' x 25'	3406258	106 lbs.	\$468.75



Contact us for volume pricing and container load programs



EPDM liners are the preferred choice for landscapers, nurseries and water garden installers because they are extremely flexible and very puncture resistant



- Fish friendly EPDM liners have been tested and have proven to be safe with fish and plants
- Highly flexible EPDM liners remain flexible in extreme temperatures, from -40° to +175°F
- Weather resistant EPDM liners are UV resistant and will not crack with age
- 20 year warranty — all Firestone liners are so durable they are under warranty for twenty years!

See www.firestonesp.com for installation videos, training and design tips



CUT LINER

- Cut to your desired length
- Multiply length x width x cost per square foot to determine liner cost



Firestone EasyPro has sold millions of square feet of 45 mil Firestone Pond Gard liner without a single case of defective or poor quality material



All rolls of liner below ship via motor freight — call for shipping quote

Part #	Description	Stocking Code	List Price Per Sq. Ft.
PL45	45 mil Liner, specify width & length	1701	\$0.89
PL60	60 mil Liner, specify 10' or 20' width x length	3936	\$1.19

45 MIL RUBBER LINER ROLLS - 50'

Part #	Liner Size	Core Length	Stocking Code	Approximate Ship Weight	List Price
PLR105	10' x 50'	6.5'	1325003	150 lbs.	\$445.00
PLR155	15' x 50'	6.5'	1487507	225 lbs.	\$667.50
PLR205	20' x 50'	6.5'	9650006	300 lbs.	\$890.00
PLR255	25' x 50'	6.5'	3812508	375 lbs.	\$1112.50
PLR305	30' x 50'	6.5'	4975002	450 lbs.	\$1335.00
PLR355	35' x 50'	11'	51137500	525 lbs.	\$1557.50
PLR405	40' x 50'	11'	21300009	600 lbs.	\$1780.00
PLR505	50' x 50'	11'	61625001	675 lbs.	\$2225.00



BOXED 45 MIL POND LINER

Several sizes of liner are available pre-cut and boxed. This is often desired in retail settings to eliminate the labor of having to cut small pieces for customers. Save time and money by allowing customers to help themselves with pre-cut liners!

Part #	Boxed Liner Size	Finished Pond Size*	Stocking Code	Ship Weight	List Price
PL810	8' x 10'	4' x 6'	356005	23 lbs.	\$71.20
PL1010	10' x 10'	6' x 6'	770001	29 lbs.	\$89.00
PL1015	10' x 15'	6' x 11'	6105003	43 lbs.	\$133.50
PL1515	15' x 15'	11' x 11'	3157507	64 lbs.	\$200.25
PL1520	15' x 20'	11' x 16'	6210001	86 lbs.	\$267.00
PL1525	15' x 25'	11' x 21'	8262503	107 lbs.	\$333.75
PL2020	20' x 20'	16' x 16'	1280003	114 lbs.	\$356.00

*Finished pond sizes are approximate and are based on a depth of 24"

45 MIL RUBBER LINER ROLLS - 100'

Part #	Liner Size	Core Length	Stocking Code	Approximate Ship Weight	List Price
PLR051	5' x 100'	6.5'	7325006	150 lbs.	\$445.00
PLR101	10' x 100'	6.5'	8650003	300 lbs.	\$890.00
PLR151	15' x 100'	6.5'	8975001	450 lbs.	\$1335.00
PLR201	20' x 100'	6.5'	61300000	600 lbs.	\$1780.00
PLR251	25' x 100'	11'	21625004	750 lbs.	\$2225.00
PLR301	30' x 100'	11'	71950001	900 lbs.	\$2670.00
PLR351	35' x 100'	11'	22275009	1,050 lbs.	\$3115.00
PLR401	40' x 100'	11'	32600001	1,200 lbs.	\$3560.00
PLR451	45' x 100'	11'	92925002	1,350 lbs.	\$4005.00
PLR501	50' x 100'	11'	43250003	1,500 lbs.	\$4450.00

60 MIL RUBBER LINER ROLLS

- Extra thick material works well in streams and waterfalls where large boulders are used
- Stocked in 10' & 20' widths, other sizes available by special order

Part #	Description	Stocking Code	Ship Weight	List Price
PL610	60 mil - 10' x 100' Roll	3860001	400 lbs.	\$1190.00
PL620	60 mil - 20' x 100' Roll	21720006	800 lbs.	\$2380.00

VOLUME DISCOUNT — If you purchase more than 15 rolls of liner per year, contact us about our volume pricing plan. We maintain a huge inventory of liner and accessories for immediate shipment!

Over 400,000 square feet of liner is stocked in our warehouse for quick shipment! Purchase a full truck load (110,000 square feet) and get free shipping along with special pricing! Contact us for details!

ALUMINUM TERMINATION BAR

- Pre-punched in 4" increments
- Use every hole when terminating underwater, every other hole above water
- Can be cut in half to ship UPS or must ship via freight in full 10' lengths

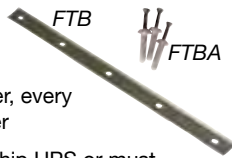

QUICKSEAM® TAPE KIT

- Contains QuickPrime (two - 4 oz cans), crayon, QuickSeam Splice Tape (25 lineal feet), QuickSeam Application Tool and complete instructions
- Ships as hazardous material with additional fees via UPS or motor freight



LINER REPAIR KIT

- Includes two 6" x 6" patches, a two ounce bottle of QuickPrime, roller, scrubber pad, disposable gloves and instructions
- Ships as hazardous material with additional fees via UPS or motor freight



PIPE BOOT

- Can be cut to fit pipes from 1" to 6⁷/₈" O.D.
- Taped flange bonds to liner and stainless clamp to tighten around pipe



HIGH STRENGTH LAP SEALANT

- Used to seal exposed edges, 11 oz. tube seals approximately 20 lineal feet, apply with standard caulking gun
- Ships as hazardous material with additional fees via UPS or motor freight



6" DIAMETER LINER PATCH

- 6" diameter circular patch with adhesive backing
- Use for quick repair of small cuts and punctures



QUICKPRIME®

- A must when joining two pieces of liner, brush on with QuickScrubber tool, **let dry to touch**, then apply tape
- Ships as hazardous material with additional fees via UPS or motor freight



WATER BLOCK

- Used to create a compression seal between liner and the substrate, approximately 10' lineal coverage with ³/₈" bead
- Ships as hazardous material with additional fees via UPS or motor freight



SEAM ROLLER

- Perfect for applying heavy pressure to the seam to properly fuse tape to liner
- Roller is made from silicone and will not stick to tape or liner



QUICK SCRUBBER® TOOL

- This handle and pad are used to clean and prepare the seam area prior to installing tape or tape accessories
- Three pads are included with each handle



SINGLE SIDED LINER TAPE

- 6" wide single sided tape used to seam two panels of liner together.
- **Note:** requires cleaning membrane prior to application, use QuickPrime to clean and improve tape adhesion



DOUBLE SIDED LINER TAPE

- Two sided tape for joining two pieces of liner together
- For maximum sealing use cover strip with this tape



Part #	Description	Stocking Code	Ship Weight	List Price
FTB	10' Termination Bar	711633	2 lbs.	\$19.39
FTBA	Concrete Anchors, 1 ¹ / ₄ "	3891	—	\$1.49
FTK	QuickSeam Tape Kit	574096	5 lbs.	\$123.49
FRK	Liner Repair Kit	220152	2 lbs.	\$33.59
FCS	One Sided Tape per foot	13704	—	\$5.29
FCS25	One Sided Tape 25' roll	564463	8 lbs.	\$92.09
FCSF	One Sided Tape 100' roll	2226168	22 lbs.	\$323.09
FST310	2 Sided Tape, 3" wide, 10' roll	113291	1 lb.	\$18.99
FST325	2 Sided Tape, 3" wide, 25' roll	228695	2 lbs.	\$40.99
FST350	2 Sided Tape, 3" wide, 50' roll	553051	4 lbs.	\$75.79
FST610	2 Sided Tape, 6" wide, 10' roll	219452	3 lbs.	\$27.79

Part #	Description	Stocking Code	Ship Weight	List Price
FST625	2 Sided Tape, 6" wide, 25' roll	745985	8 lbs.	\$65.69
FST650	2 Sided Tape, 6" wide, 50' roll	379589	15 lbs.	\$113.69
FPB	Pipe Boot	237437	2 lbs.	\$62.39
FLS	Lap Sealant, 11 oz. Tube	610255	1 lb.	\$17.09
FJC	6" Circular Patch	45097	1 lb.	\$8.49 each
FQPQ	QuickPrime, 1 Quart	637673	3 lbs.	\$62.79
FQP	QuickPrime, 1 Gallon	349131	10 lbs.	\$81.89
FWB	Water Block, 10 oz. Tube	511277	1 lb.	\$18.79
FSR	Seam Roller	430838	2 lbs.	\$51.39
FQT	Scrubber Tool	68331	2 lbs.	\$13.89

Reinforced Woven Polyethylene Pond Liners



Ideal for lining large ponds – up to 65,000 square feet in one piece!

Custom made to your exact pond size!

These polyethylene liners are engineered to offer great strength in a light weight liner material. The material is UV stabilized to offer years of worry free protection against the damaging rays of the sun. Unlike regular multi-layered liners which simply stack the layers of liner on top of each other, these liners are woven together – this gives the ultimate in strength. Because of the light weight and strength, these liners can be manufactured in sizes up to 65,000 square feet.

- Unlike PVC liners, which need 12" of soil over the entire liner, these liners do not require coverage other than around the edges – this lowers the overall installation cost dramatically!
- Custom made liners require approximately 10-14 days for manufacturing and delivery

20 year warranty when under water

10 year warranty when exposed to direct sunlight

PSI Burst Strength Comparison (Mullen Test)

24 mil EasyWeave - AW24S	740 lbs.
40 mil EasyWeave - AW40	1220 lbs.
30 mil PVC	226 lbs.
60 mil HDPE	541 lbs.

Testing done by TRI Environmental, Austin, Texas

EasyWeave Liners are Super Strong!



60,000 square feet - one piece



91,000 square feet - two pieces



114,000 square feet - three pieces



See our website for a video installation of the 21,000 square foot liner below



EASYWEAVE POND LINER

Part #	Thickness	Square Feet Quantity	Stocking Code	Ship Weight per 1000' sq. ft.	List Price per sq. ft.
AW24S	24 mil - Triple Ply	1000 - 10000	6429	75 lbs.	\$0.65
		10001 - 20000	2403		\$0.62
		20001 or more	4375		\$0.59
AW30S	30 mil - Triple Ply	1000 - 10000	9460	121 lbs.	\$0.69
		10001 - 20000	5448		\$0.66
		20001 or more	3421		\$0.63
AW24	24 mil - Five Ply	1000-10000	1496	95 lbs.	\$0.69
		10001-20000	2475		\$0.66
		20000 or more	4443		\$0.63
AW40	40 mil - Five Ply	1000-10000	8560	150 lbs.	\$0.76
		10001-20000	5547		\$0.73
		20000 or more	3529		\$0.70

LINER SEAMING TAPE

Part #	Description	Stocking Code	Ship Weight	List Price
EWT1F	4" Single Sided Tape per foot	92074	—	\$3.19 per ft.
EWT1	4" x 50' Single Sided Tape	582091	9 lbs.	\$126.29
EWT2	2" x 50' Double Sided Tape	269610	5 lbs.	\$107.09

- Tape-on and Weld-on pipe boots up to 48" diameter are available - please inquire



Greenline Inc. (MI)

Bottom Drains

3" BDA AND BD1 BOTTOM DRAINS

- Available with (BDA) or without (BD1) air diffuser in lid, using air increases circulation and cleaning capacity
- Both have dual rubber gaskets and six stainless screws for water tight penetration through liner
- For use with 3" schedule 40 PVC fittings and pipe
- BDA has 1/2" barbed inlet fitting, recommended air flow through diffuser is .5 - 1.5 cfm

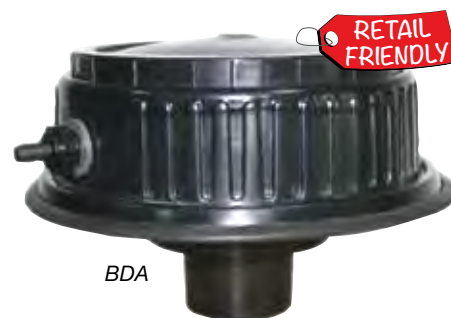

4" EBD4 AND EBD4A BOTTOM DRAINS

Heavy duty, roto-molded design offers superior strength



- Threaded center stand pipe securely attaches dome lid to base
- Sixteen stainless screws securely attach liner ring to base with water tight seal through liner
- For use with 4" schedule 40 PVC fittings and pipe, use 4" male adapter (MA40) to connect to 4" pipe, use reducing male adapter (RMA4030) to connect to 3" pipe
- EBD4A incorporates an air diffuser into the dome lid — incoming air is delivered up through the center stand pipe allowing air tubing to be installed under liner
- EBD4A tubing adapter is 1/2", recommended air flow through diffuser is .5 - 1.5 cfm



Part #	Description	Stocking Code	Ship Weight	List Price
BD1	3" Bottom Drain	362780	4 lbs.	\$96.59
BDA	3" Bottom Drain with Air Diffuser	697174	5 lbs.	\$149.49
EBD4	4" Heavy Duty Bottom Drain	2110626	10 lbs.	\$170.19
EBD4A	4" Bottom Drain with Air Diffuser	9148521	12 lbs.	\$228.49
RMA4030	4" Threaded x 3" Slip PVC Adapter	58388	1 lb.	\$12.89
MD3	Replacement Air Diffuser for BDA/EBD4A	833143	2 lbs.	\$44.19

PROFESSIONAL BOTTOM DRAIN KITS

Many pond builders have found that adding a bottom drain helps keep a pond cleaner. Fish waste and other muck that accumulates on a pond bottom can be easily removed by a bottom drain. Ponds that are over 2' deep can become stagnant without a bottom drain.

- Installed under the liner, flex PVC pipe carries the water under the liner to the skimmer box. Bulkhead fitting is installed in the skimmer, a PVC male adapter connects the flex PVC to the bulkhead fitting. The valve (included) is placed inside the skimmer box to control flow.
- Kits include bottom drain, bulkhead fitting, valve and fittings — does not include PVC pipe
- BDK2 kits include BD1 bottom drain and are intended for use with 2" pipe
- BDK3 kits include EBD4N bottom drain and are intended for use with 3" pipe

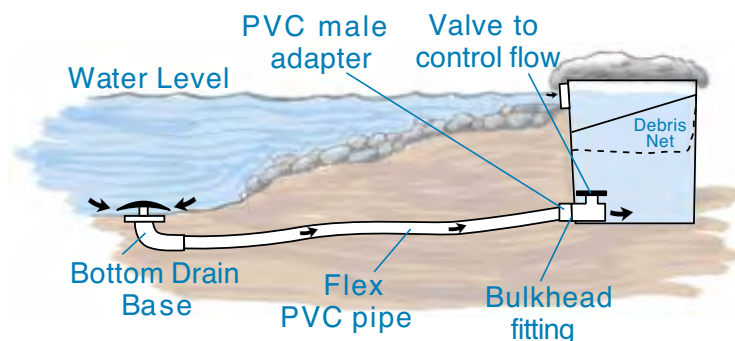

Part #	Description	Stocking Code	Ship Weight	List Price
BDK2N	Bottom Drain Kit with BD1 Drain	3114858	7 lbs.	\$176.69
BDK2A	Bottom Drain Kit with BDA Drain including Air Diffuser	1129412	8 lbs.	\$199.09
BDK3N	Bottom Drain Kit with EBD4 Drain	9158620	14 lbs.	\$234.99
BDK3A	Bottom Drain Kit with EBD4A Drain including Air Diffuser	5188994	15 lbs.	\$279.99

Pump Pro-Tectors

Protect against plugging by creating a large surface area around the pump

- Designed to fit all brands of small pumps
- Has a polyester filter media pad inside of a nylon mesh bag
- Drawstring top with push button release keep the top closed around the pump yet makes for easy pump removal
- PP8 has an 8" diameter and 1" thick sidewalls allowing pumps up to 6" diameter
- PP12 has a 12" diameter and has 2" thick sidewalls allowing pumps up to 8" diameter



PP8

PP12

Part #	Max. GPH Flow	Case Quantity	Stocking Code	Ship Weight	List Price
PP8	1250	6	319495	2 lbs.	\$29.99
PP12	2550	4	425996	3 lbs.	\$39.99

SAVE 5% ON A CASE!

Floating Fountain with LED Lights



Arch Nozzle

Create a decorative fountain in water features and small ponds

- 12" diameter fountain head comes with **both** spray nozzles shown
- Can be purchased as fountain head only or as a complete unit with mag drive pump, see chart below
- Recommended pump size of 400 - 1350 GPH
- 48 diode LED light ring - you may select color or set to automatic which changes slowly from color to color
- 32' power cord and UL listed transformer included
- 3/4" barb fitting for easy connection to vinyl tubing
- Kits ship complete with pump, LED lights, fountain head and 6' tubing



3 Tier Nozzle

Includes Two Nozzles!



Part #	Description	Case Quantity	Stocking Code	Ship Weight	List Price
EPFH	Fountain Head Only	4	6123441	7 lbs.	\$164.59
EPFH6	Fountain Head & EP600 Pump	2	2184278	14 lbs.	\$259.69
EPFH13	Fountain Head & EP1350 Pump	2	9239363	16 lbs.	\$344.49

SAVE 5% ON A CASE!



MB21

RETAIL FRIENDLY

Mesh Media Bags

Holds all types of media including salt, carbon, zeolite, barley pellets, filtration media and more!

- EMB1, EMB2 and EMB3 are 1/8" mesh and have drawstring with push button release
- MB21 and MB22 are 1/4" mesh and have drawstring with push button release
- MB18F is 3/16" fine mesh and has drawstring with push button release



EMB2

SAVE 5% ON A CASE!

Part #	Description	Dimensions	Stocking Code	Ship Weight	List Price
EMB1	Mesh Media Bags, 1/8" mesh, 12 per case	12" x 12"	34937	1 lb.	\$7.59
EMB2	Mesh Media Bags, 1/8" mesh, 12 per case	12" x 18"	66303	1 lb.	\$9.69
EMB3	Mesh Media Bags, 1/8" mesh, 12 per case	18" x 18"	78252	1 lb.	\$12.69
MB18F	Media Bag, 3/16" fine mesh	18" x 30"	311871	1 lb.	\$17.59
MB21	Media Bag, 1/4" mesh	21" x 30"	412621	1 lb.	\$18.69
MB22	Media Bag, 1/4" mesh	22" x 26"	712623	1 lb.	\$18.69

Great bags to use with media on page 76!

Telescoping Pond Net

Great all around pond net for skimming leaves, catching fish, etc.

- Aluminum frame and handle are light weight and very strong
- Net measures 17" x 18" x 16" deep mesh and is flat along the front making it easier to catch fish
- 32" - 60" telescoping handle is octagon shaped and is super strong with detachable head for easy cleaning and storage

SAVE 5% ON A CASE!



RETAIL FRIENDLY



Part #	Description	Case Quantity	Stocking Code	Ship Weight	List Price
EPN	Telescoping Pond Net	6	722616	4 lbs.	\$34.79

Fish Shipping Bags

These high quality bags are made for EasyPro by a major bag manufacturer

- Most commonly used for hauling live fish
- Bags are made from the finest materials
- Our standard bag is 18" x 34", 3 mil and guaranteed waterproof
- Available in 100 or 250 count box.



Part #	Description	Stocking Code	Ship Weight	List Price
OB100	18" x 34" Bag, 100 Count Box	839525	12 lbs.	\$52.69
OB250	18" x 34" Bag, 250 Count Box	393898	31 lbs.	\$125.19

Bander & Bands

Use this handy tool to quickly and securely close your fish shipping bags. For maximum holding power use two bands at a time on each bag.

Part #	Description	Stocking Code	Ship Weight	List Price
BBT	Bag Sealing Tool	322325	2 lbs.	\$31.89
BB	Bands, 100 per Bag	44121	1 lb.	\$5.89 bag



pond monsta

The Pond Monsta is a revolution in pond cleaning!

The Pond Monsta is a continuous cleaning system that is up to four times faster than traditional pond vacuums that have to be emptied over and over. Leaves and other debris are sucked up through the system and pumped into a debris collector. Water from the collector can be recycled back into the pond if sludge content is not high. For high sludge content, water can be discharged onto lawn, flower beds, etc.

- Powerful 115v, 350w motor with 40' power cord
- Remote control on/off button built into handle
- Two year warranty
- Much quieter than traditional pond vacuums with motor underwater
- Spare impeller included with every unit
- With over 15,000 units sold in Europe it has been thoroughly tested

Package Includes:

- Submersible cleaning head
- 20' discharge hose
- 7' telescoping aluminum handle
- Debris collection basket

See our website for demo video clip!

Finally! After 20 years, one that works. With multiple fish ponds and tanks to clean every week, in addition to customer's ponds, we needed something that had a lot of power and wasn't too clumsy to use. I saved 45 minutes on a 2 hour job the first time I used the Pond Monsta! The first customer I lent it to had no problems and was very happy with the results.



Don Apol of Apol's Watergardens
Caledonia, MI



New Lower Price!



PMVB

Part #	Description	Stocking Code	Ship Weight	List Price
PMV35	Pond Monsta Cleaning System	8307993	24 lbs.	\$439.99
PMVH4	Pond Monsta 4' Extension Handle	120014	4 lbs.	\$28.59
PMV12H	12" Brush Head	519940	2 lbs.	\$28.49
PMVB	2' x 4' Weather Proof Banner	25007	1 lb.	\$9.99

Matala® Pond Vacuum

- Four times more power than similar style vacuums
- Suction lift 5' above water
- Auto fill and drain cycle
- Powerful 2 hp motor
- Holds 5.3 gallons of water
- Includes vacuum, five extension tubes, four nozzles, discharge hose, suction hose, sludge collection bag and assembly hardware
- 16' suction hose
- 8' discharge hose
- 16' power cord



Part #	Description	Stocking Code	Ship Weight	List Price
MPV2	Pond Vacuum II	9202491	27 lbs.	\$299.99

Ultrasonic Repeller

Safe, easy way to keep unwanted pests away

- A great way to protect against unwanted pests
- Can be used around ponds, in the garden or anywhere you want to keep animals away
- Motion detector senses animal and emits a loud, piercing ultrasonic sound at a frequency that people can't hear
- Weather resistant for years of outdoor use
- Operates on six "C" cell batteries which provide up to 2,000 activations
- Adjustable frequency and detection area
- Includes mounting stake for ground use or can be hung on wall, posts, etc.

Blends Easily Into Any Landscape!

SAVE 5% ON A CASE!

Part #	Description	Case Quantity	Stocking Code	Ship Weight	List Price
ULTR6	Ultrasonic Repeller	6	756418	2 lbs.	\$86.79



RETAIL FRIENDLY

ULTR6

Gator Guard

Protect your fish from herons and raccoons

- Life size floating replica of alligator head — a great deterrent to geese, ducks, herons and raccoons. **It works because it moves!**
- Stationary products lose effectiveness unless you move them regularly, the gator guard works because it moves with the wind and water motion plus the mirrored eyes flash in the sun - birds think they're being followed
- 25 threatening inches long

SAVE 5% ON A CASE!

Part #	Description	Case Quantity	Stocking Code	Ship Weight	List Price
GG25	25" Gator Replica	4	660541	5 lbs.	\$86.49



GG25



RETAIL FRIENDLY

SCARECROW Motion Activated Sprinkler

A safe and effective way to keep unwanted animals out of your garden or away from your pond. This unique product uses a sudden burst of water to harmlessly scare away intruders.

- Runs for months on one 9 volt battery
- Water conscious — only uses two to three cups per blast
- Effectively keeps cats, dogs, raccoons, herons, deer, rabbits and other pests away. Animals never get used to the blast of water unlike other scarecrow devices which animals soon adapt to.
- Two year warranty
- Connects to standard garden hose

Part #	Description	Case Quantity	Stocking Code	Ship Weight	List Price
SCARE	Scarecrow Sprinkler	6	461423	2 lbs.	\$94.49



SCARE

RETAIL FRIENDLY

2 year LIMITED WARRANTY

SAVE 5% ON A CASE!

30 day MONEY BACK guarantee



Ornamental Pond Aerators & Deicers

Installing an aeration system has many benefits including:

- Ensures adequate oxygen levels during hot summer months
- Maintains open water during winter months in freezing climates eliminating winter kill
- An energy efficient way to aerate, destratify and circulate water in water gardens and koi ponds
- Increased oxygen levels, which will help with decomposing organic material, result in a cleaner and healthier pond
- Reliable — linear compressors have few moving parts making them less likely to need repair
- Easy to install — compressors sit on shore connected by tubing to bottom mounted air diffusers



Center Point Pond (PA)

EasyPro aeration systems provide year around benefit for only pennies per day in operating costs!



Economy Aeration Systems



EPA1

- Continuous duty compressor with 6' power cord
- Includes 30' of vinyl tubing, air diffuser
- Two watt compressor will operate up to 4' deep



EPA2

- Continuous duty compressor with adjustable air flow, 4' power cord and dual air outlets
- Includes two 30' rolls of vinyl tubing and two air diffusers
- Three watt compressor will operate up to 5' deep



EPA4

- Continuous duty compressor with adjustable air flow, 4' power cord and four air outlets
- Includes four 30' rolls of vinyl tubing and four air diffusers
- Five watt compressor will operate up to 5' deep

Part #	Description	Approximate Pond Size*	Warranty	Stocking Code	Ship Weight	List Price
EPA1	Aeration Kit, Single Diffuser	Up to 800 Gallons	1 Year	656244	4 lbs.	\$74.99
EPA2	Aeration Kit, Dual Diffusers	Up to 1200 Gallons	1 Year	363740	5 lbs.	\$84.99
EPA4	Aeration Kit, Quad Diffusers	Up to 1500 Gallons	1 Year	978742	6 lbs.	\$104.99

*Fish load, filtration capacity and other factors affect actual maximum pond size

Compressors require proper enclosure if used outdoors

Economy Linear Aeration Kits

2 Year Warranty!

- Diaphragm linear aeration kits include weather resistant compressors allowing use outdoors
- Powered by quiet, continuous duty compressors, these small aerators do a great job of aerating all year long
- Can be used in ponds up to 6' deep!

LA5N

Includes:

- EPW2 compressor
- 15' of QuickSink weighted tubing
- RAD6 air diffuser



LA15N

Includes:

- EPW6 compressor
- Four way air splitter
- 50' of QuickSink weighted tubing
- Two RAD1250 air diffusers



LA10N

Includes:

- EPW4 compressor
- 15' of QuickSink weighted tubing
- RAD8 air diffuser



LA20N

Includes:

- EPW10 compressor
- Four way air splitter
- Two 50' rolls of QuickSink weighted tubing
- Four RAD1250 air diffusers



Part #	Compressor Included	CFM Air Output	Aerates Ponds Up To	Electrical Usage	Warranty	Stocking Code	Ship Weight	List Price
LA5N	EPW2	.8	3000 gallons	15 watts	2 years	6139994	11 lbs.	\$199.99
LA10N	EPW4	1.8	8000 gallons	34 watts	2 years	3181997	17 lbs.	\$259.99
LA15N	EPW6	2.5	17,500 gallons	45 watts	2 years	1300990	30 lbs.	\$429.99
LA20N	EPW10	5.2	40,000 gallons	96 watts	2 years	8412992	47 lbs.	\$589.99

Deluxe Linear Aeration Kits

EasyPro piston linear aeration kits are truly the finest systems on the market today! They offer one of the longest warranties of any air pump available because they are the best built air pump you can buy!

- Extra Quiet — you can barely hear them from only 5' away
- Energy Efficient — operates for only pennies per day
- Very Reliable — motors can often run constant for 5 - 8 years
- Oil-less Design — provides clean, dry air with minimal maintenance
- UL listed — for outdoor use
- Each kit includes compressor, 15' of weighted airline and air diffuser

3 Year Warranty!

EasyPro also specializes in large lake and pond aeration ...

Visit our website for more information or to request our lake and pond catalog.

www.easypropondproducts.com



LA5W

Includes ML28 compressor, 15' of QuickSink weighted tubing and RAD6 air diffuser



LA15W

Includes ML80 compressor, 15' of QuickSink weighted tubing and two RAD1250 air diffusers connected together



Part #	Compressor Part Number	CFM Air Output	Aerates Ponds Up To	Electrical Usage	Warranty	Stocking Code	Ship Weight	List Price
LA5W	ML28	1.0	3,000 gallons	25 watts	3 years	3270459	13 lbs.	\$383.69
LA10W	ML45	1.6	7,500 gallons	45 watts	3 years	7330285	18 lbs.	\$467.59
LA15W	ML80	2.8	20,000 gallons	80 watts	3 years	9425724	24 lbs.	\$602.39

See page 60 for more information on compressors.

Mini Air Compressors



- These small continuous duty air compressors each feature adjustable air output
- Chose from single, double or quad air outputs - each is 3/16" aquarium tubing



RAS1 Diffuser

Diaphragm Repair Kits

Part #	Stocking Code	List Price
MC8RK	110128	\$13.49
MC10RK	611474	\$15.29

(MC6 does not have repair kit)

Part #	CFM	Air Outlets	Watts	Max. Depth	Power Cord	Stocking Code	Ship Weight	List Price
MC6	.3	1	2	4'	6'	650620	3 lbs.	\$67.49
MC8	.4	2	3	5'	4'	258048	4 lbs.	\$77.39
MC10	.5	4	5	5'	4'	769441	5 lbs.	\$92.59
RAS1	Replacement Air Diffuser	-	-	-	-	42995	1 lb.	\$3.99

Compressors require proper enclosure if used outdoors

Low Cost, Continuous Duty Linear Diaphragm Compressors



- Ideal for aerating ponds, water features, bait tanks or large aquariums
- Two year warranty
- 5' power cord with 115 volt plug included
- Weather resistant enclosures for outdoor use
- Energy efficient - operates on only a few watts of power
- Reliable - linear compressors have few moving parts making them very reliable



Diaphragm Repair Kits

Part #	Stocking Code	List Price
EPW2RKN	815731	\$21.69
EPW4RK	117183	\$23.69
EPW6RK	519647	\$27.09
EPW10RK	421029	\$28.99



Many other air compressors available in our Lake & Pond Catalog

Part #	Watts	Max. Depth	Air Outlet Size	CFM Air Flow @ Water Depth of:						Stocking Code	Ship Weight	List Price
				0'	2'	4'	6'	8'	10'			
EPW2	15	8'	5/8"	0.8	0.6	0.5	0.4	-	-	6120921	8 lbs.	\$166.79
EPW4	35	11'	3/4"	1.8	1.6	1.3	1.0	0.9	0.6	2161387	12 lbs.	\$222.59
EPW6	45	12'	3/4"	2.5	2.3	2.0	1.8	1.7	1.4	9198356	15 lbs.	\$273.59
EPW10	96	14'	3/4"	5.2	5.0	4.6	4.1	3.6	3.1	3216844	18 lbs.	\$299.09

Linear Piston Compressors



Highest quality air compressors on the market today!

- Quiet, energy efficient, weather resistant and durable
- These compressors utilize a small piston instead of a diaphragm to pump air
- It is not at all uncommon for these motors to operate continuously for seven to nine years! A perfect choice for summer and winter aeration needs.
- UL listed for outdoor use — ideal for pond aeration
- 5' power cord with 115 volt plug included
- A 1/2" rubber elbow is included for outlet connection

Part #	Watts	Max. Depth	Air Outlet Size	CFM Air Flow @ Water Depth of:					Stocking Code	Ship Weight	List Price
				0'	2'	4'	6'	8'			
ML28	28	6'	5/8"	1.4	1.3	0.8	0.3	-	6239741	8 lbs.	\$342.49
ML45	45	8'	3/4"	1.8	1.6	1.4	0.9	0.3	5283147	8 lbs.	\$404.49
ML80	80	9'	3/4"	3.1	2.8	2.6	1.6	0.5	2356718	14 lbs.	\$509.59
ML120	120	10'	1"	5.1	5.0	4.6	3.5	1.6	4558036	21 lbs.	\$797.19

Rubber Membrane Air Diffusers

- Incredibly strong and are ideal for pond aeration, circulation and destratifying applications
- Unlike air stones these diffusers are easy to clean
- Barbed inlets have multiple size barbs, cut to fit
- Twelve per case (12" has six per case)

SAVE 5% ON A CASE!



Part #	Length	Inlet Air Fitting	Maximum CFM Airflow	Stocking Code	List Price
RAD4	4"	1/4" - 3/8"	1.1	68847	\$11.79
RAD6	6"	1/4" - 3/8"	1.7	511624	\$15.49
RAD650	6"	1/2" MPT	1.7	811622	\$15.49
RAD8	8"	3/8" - 1/2"	2.5	613125	\$17.49
RAD850	8"	1/2" MPT	2.5	713124	\$17.49
RAD12	12"	3/8" - 1/2"	3.5	419276	\$25.69
RAD1250	12"	1/2" MPT	3.5	219278	\$25.69

Pro-Glass Alumina Air Stones

Part #	Dimensions	Fitting Size	Recommended Airflow (CFM)	Stocking Code	Ship Weight	List Price
AS15	1 1/2" x 1 1/2" x 1 1/2"	3/16" barb	.20	46222	1 lb.	\$8.89
AS325	1 1/2" x 1 1/2" x 3"	1/4" barb	.30	69021	1 lb.	\$12.89
AS337	1 1/2" x 1 1/2" x 3"	3/8" barb	.30	99093	2 lbs.	\$12.99
AS625	1 1/2" x 1 1/2" x 6"	1/4" barb	.5	511758	2 lbs.	\$16.79
AS637	1 1/2" x 1 1/2" x 6"	3/8" barb	.5	811754	2 lbs.	\$16.79
AS650	1 1/2" x 1 1/2" x 6"	1/2" npt	.5	711966	2 lbs.	\$17.09
AS937	1 1/2" x 1 1/2" x 9"	3/8" barb	.75	221975	2 lbs.	\$31.39
AS950	1 1/2" x 1 1/2" x 9"	1/2" npt	.75	622047	2 lbs.	\$31.49
AS1237	1 1/2" x 1 1/2" x 12"	3/8" barb	1.0	323869	3 lbs.	\$34.09
AS1250	1 1/2" x 1 1/2" x 12"	1/2" npt	1.0	524002	3 lbs.	\$34.29

Stainless Steel Hose Clamps

Part #	Size	Stocking Code	Case Quantity	List Price
HC1	1/4" - 5/8"	71128	100	\$1.49
HC2	5/16" - 7/8"	21123	100	\$1.49
HC3	7/16" - 1"	41341	100	\$1.79



SAVE 10% ON A CASE!

RealRock™ Landscape Boulders

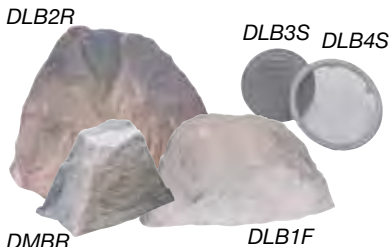

These RealRock™ Boulders are ideal for concealing air pumps, water pumps, pond filters, UVs, lighting transformers and other equipment.

- Commercial grade construction stands up to the elements, will not fade or crack, recycled material
- All rocks come standard with one vent, additional vents can be ordered if needed

Three Sizes:

DMBR - Measures 19" long x 14" wide x 12" high, includes one 3" vent

DLB1 - Measures 30" long x 23" wide x 18" high, includes one 3" vent

DLB2* - Measures 56" long x 42" wide x 30" high, includes one 4" vent, *ships motor freight

Part #	Color	Recommended For	Case Quantity	Stocking Code	Ship Weight	List Price
DMBR	Brown	Linear Compressors, MC6-ML80	10	862622	4 lbs.	\$83.49
DLB1F	Gray	Compressors up to PA66, Small Pond Filters	6	393071	6 lbs.	\$124.09
DLB1R	Brown	Compressors up to PA66, Small Pond Filters	6	793074	6 lbs.	\$124.09
DLB2F*	Gray	PA75+ or Multiple Compressors	4	6244648	28 lbs.	\$326.19
DLB2R*	Brown	PA75+ or Multiple Compressors	4	9244643	28 lbs.	\$326.19
DLB3S	—	Additional 3" Louvered Vent Installed	-	310726	1 lb.	\$14.29
DLB4S	—	Additional 4" Screened Vent Installed	-	217845	1 lb.	\$23.79

"Quick Sink" Weighted PVC Airline



5 Year Warranty!

MADE IN THE USA

Thick wall PVC hose

is guaranteed not to crack or split! Works in all temperatures for easy installation even in cold weather!

Part #	Length	Stocking Code	Ship Weight	List Price
3/8" QUICK SINK AIRLINE (.687" O.D.)				
L3PVC	Cut any length	1994	20 lbs./100'	\$1.32/foot
L3PVC5	50' Roll-Boxed	344397	10 lbs.	\$59.19
L3PVC1	100' Roll-Boxed	785272	20 lbs.	\$113.69

Part #	Length	Stocking Code	Ship Weight	List Price
1/2" QUICK SINK AIRLINE (1" O.D.)				
L5PVC	Cut any length	31554	44 lbs./100'	\$2.06/foot
L5PVC1	100' Roll-Boxed	4133423	44 lbs.	\$177.89

Part #	Length	Stocking Code	Ship Weight	List Price
5/8" QUICK SINK AIRLINE (1.12" O.D.)				
L6PVC	Cut any length	31791	53 lbs./100'	\$2.38/foot
L6PVC1	100' Roll-Boxed	6147144	53 lbs.	\$196.19

Quantity discounts available - call for details!

3/4" diameter and 500' rolls available in our Lake & Pond catalog

Two Way Splitter



- Divide air from a single incoming line into two outgoing lines
- Brass valves control air flow between each line

Part #	Size	Stocking Code	Ship Weight	List Price
2WAY2	1/2" x 1/2"	730150	3 lbs.	\$41.59

Air Diffuser Manifold

- Includes check valve to prevent water from filling air line when not in use and 12" x 21" underlay
- Comes with two 6" long standard air diffusers, standard airline connection is for 1/2" poly tubing
- Recommended airflow (CFM) .8 - 3.4

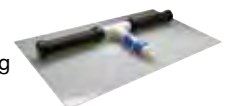

Part #	Stocking Code	Ship Weight	List Price
DM2	357926	8 lbs.	\$79.89

MADE IN THE USA



Thermo-Pond

Energy efficient deicer uses only 100 watts of power

- Tested in Northern Wisconsin ponds down to -39°F
- Not intended to heat water but rather to keep a hole open in the ice to allow harmful gases to escape
- Completely enclosed in plastic — no danger of heating element damaging liner!
- These deicers cost a little more than other deicers, but the electrical savings will pay for itself in the first month!



Thermo-Pond

Perfect Climate Deluxe Pond Deicers

Can be used as a surface deicer or converts in seconds to a bottom heater

- Safe for all ponds
- Thermostatically controlled — operates only when needed, saving electricity
- Easy to remove float ring allows deicer to be used as a bottom heater



Floating Pond Deicer



Pondmaster offers a winter pond deicer designed to maintain a small open area allowing harmful gases to escape

- Internal parts epoxy sealed for protection
- 120 watt - very energy efficient
- Made from rugged ABS plastics for years of use
- Thermostatic control to reduce heating cost

Part #	Description	Power Cord	Warranty	Case Quantity	Stocking Code	Ship Weight	List Price
TP100	100 Watt Heater/Deicer	12'	1 year	6	644581	3 lbs.	\$68.59
TPH250	250 Watt Heater/Deicer	12'	1 year	6	242110	3 lbs.	\$64.79
TPH750	750 Watt Heater/Deicer	12'	1 year	6	446666	3 lbs.	\$71.79
TPH1500	1500 Watt Heater/Deicer	12'	1 year	6	548611	4 lbs.	\$74.79
PFD120*	120 Watt Deicer	18'	1 year	4	744583	3 lbs.	\$68.59

*Does not receive case quantity discount

SAVE 5% ON A CASE!



Pond deicers are used to keep a small hole open in the ice during freezing conditions. This small hole allows potentially harmful gas to escape from the pond water. The gas is caused by decomposing leaves, dead algae, fish waste, etc. and will become lethal if levels become too high. Maintaining a small opening vents the gas.

Premium Pond Cover Netting

- Strong black netting will last for years!
- Currently most other manufacturers offer a small variety of prepackaged netting that do not fit the needs of many pond or stream applications, EasyPro Premium Pond Cover Netting is available in 10', 20' and 30' wide rolls each 100' long
- You simply pull out the length needed, cut it and BINGO — you have a cover net exactly the length you need
- Selling EasyPro netting allows you to cut your inventory down to only three SKUs and greatly increases your selling choices
- By stocking pond cover netting like you would stock liner, inventory is minimized but size choices are increased!
- A variety of prepackaged sizes are also available
- Custom cut pieces are available allowing you to buy just what you need, please specify length when ordering, 10', 20' or 30' wide



PRE-CUT NETTING:

Part #	Description	Case Quantity	Stocking Code	Ship Weight	List Price
NP1515	Premium - 3/4", 15' x 15', w/8 Stakes	12	219884	2 lbs.	\$30.59
NP2020	Premium - 3/4", 20' x 20', w/8 Stakes	12	634838	3 lbs.	\$53.59
NP2030	Premium - 3/4", 20' x 30', w/10 Stakes	8	445496	5 lbs.	\$69.99
NP3030	Premium - 3/4", 30' x 30', w/12 Stakes	8	559082	7 lbs.	\$90.89
NRS12	12 Pack Netting Stakes	—	18389	1 lb.	\$12.89

Pond cover netting in bulk. Available in 10', 20' and 30' widths — cut to length for a perfect fit. Bulk rolls come packaged in a box for easy display on store shelves, simply pull out desired length and cut!

BULK NETTING:

NR101	Premium - 3/4", Boxed 10' x 100'	—	364541	6 lbs.	\$99.29
NR201	Premium - 3/4", Boxed 20' x 100'	—	6127984	10 lbs.	\$196.89
NR301	Premium - 3/4", Boxed 30' x 100'	—	8192650	14 lbs.	\$296.39
NR101F	Premium - 3/8" Fine Mesh 10' x 100'	—	7113483	10 lbs.	\$174.59
NR201F	Premium - 3/8" Fine Mesh 20' x 100'	—	4231138	13 lbs.	\$355.59
CNR34	Premium - 3/4" Cut to Length 10', 20' or 30' wide	—	5103	—	\$0.20/sq. ft.
CNR38	Premium - 3/8" Cut to Length 10' or 20' wide	—	8147	—	\$0.24/sq. ft.

Custom Size Nylon Pond Covers

NPC is white nylon and NPCT is black U.V. stabilized, this nylon netting will last for years!

- Need a large pond cover? No problem! We can have any width and length pond cover made for you using a heavy duty nylon mesh that is far superior in strength to any of the plastic covers on the market.
- Nylon mesh has 1" square openings. A thick rope border around the net prevents tearing of the mesh even when loaded with leaves!
- Allow 7-10 days for delivery due to custom nature of product
- Minimum order 100 square feet on both NPC and NPCT netting



Part #	Description	Stocking Code	Ship Weight	List Price
NPC	Custom Sized - 1" Mesh Net, White*	7295	—	\$0.56/sq. ft.
NPCT	Custom Sized - 1" Mesh Net, Black*	2313	—	\$0.60/sq. ft.



NPCT

Platinum Koi & Goldfish Food

EasyPro has combined the latest in ingredients and technology to give you a superior fish diet. Developed through decades of research, these diets are fed by leading breeders and producers with consistently great results! All EasyPro koi foods share these major benefits:

- Contains stabilized vitamin C and brewers yeast to promote fish development
- Formulated for easy digestibility minimizing waste from fish
- Contains all natural nutritional supplement designed to improve disease resistance
- Nitrogen preserved to increase freshness and shelf life - **up to two years!**

SAVE 5% ON A CASE!

MAX COLOR FOOD

- A high quality feed designed to provide a staple diet and enhance the vibrant colors in your fish
- Fortified with spirulina and other marine ingredients to enhance the natural coloration of koi and goldfish
- 5.0 mm (3/16") floating pellet, ideal for larger fish



MAX GROWTH & COLOR FOOD

- A high performance diet designed for growing fish
- Fortified with spirulina and other marine ingredients for maximum color
- Does not cloud water
- 3.0 mm (1/8") floating pellet, ideal for young fish



Part #	Description	Pellet Size	Case Quantity	Stocking Code	Ship Weight	List Price
PC1	Max Color, 20 oz. Canister	3/16"	12	510655	2 lbs.	\$16.39
PC5	Max Color, 5 lb. Zipper Bag	3/16"	4	422352	6 lbs.	\$34.39
PC33	Max Color, 33 lb. Bulk Bag	3/16"	2	990478	35 lbs.	\$139.19
PG1	Max Growth & Color, 20 oz. Canister	1/8"	12	811246	2 lbs.	\$17.29
PG5	Max Growth & Color, 5 lb. Zipper Bag	1/8"	4	725150	6 lbs.	\$38.69
PG33	Max Growth & Color, 33 lb. Bulk Bag	1/8"	2	389431	35 lbs.	\$137.59

COLD WATER FOOD (Wheat Germ)

- Wheat based diet ideal for feeding during colder periods of the year
- Low protein, low fat diet that is easily digested by fish during colder water temperatures
- 5.0 mm (3/16") floating pellet with two year shelf life



GAME FISH FOOD

- High quality general purpose fish food designed for feeding trout, bluegill, catfish and other game fish in farm ponds and lakes
- Floating pellets available in 3.0 mm (1/8") for younger fish or 5.0 mm (3/16") for larger fish



Part #	Description	Pellet Size	Case Quantity	Stocking Code	Ship Weight	List Price
CWF1	Cold Water Food, 20 oz. Canister	3/16"	12	18442	2 lbs.	\$12.99
CWF5	Cold Water Food, 5 lb. Zipper Bag	3/16"	4	318977	6 lbs.	\$29.19
FD18*	Game Fish Food, 44 lb. Bag	1/8"	—	932000	48 lbs.	\$39.99
FD316*	Game Fish Food, 44 lb. Bag	3/16"	—	532001	48 lbs.	\$39.99

* FD18 and FD316 not available for case quantity discount.

Water temperature has a direct bearing on fish metabolism. The warmer the water, the faster the metabolism and need for food. Here is a feeding breakdown based on temperature:

Above 65° High levels of protein are needed for growth and energy. Feed fish two to three times a day.

45° to 65° As water temperatures cool down koi need less protein and more carbohydrates in their diet.

Below 45° Once the water temperatures drop into the low 40's and below, it is not recommended to feed koi. Their metabolism drops to a point where they cannot digest feed.

GROWTH & ENERGY FOOD With Added Color Enhancer

If you want your koi to achieve maximum growth this is your feed! Microbe-Lift's high growth food has 40% protein which achieves maximum growth and high energy levels.

- Color enhancers included for maximum color
- Feed when water is over 68°F
- To be fed as a primary diet all Summer long for fastest growth and high energy levels



SUMMER STAPLE FOOD With Added Color Enhancer

This Summer staple food has animal proteins and color enhancers that fish need during warm Summer months.

- Contains spirulina and krill for color enhancement
- Guaranteed 36% protein, 6% fat content
- Medium pellet size, for fish 6" and larger

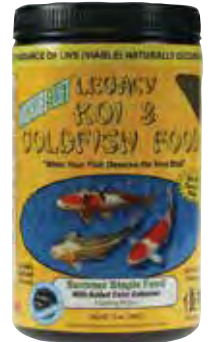

Part #	Description	Size	Case Quantity	Stocking Code	Ship Weight	List Price
MLHG1	Growth & Energy with Color Enhancer	12 oz.	12	78591	2 lbs.	\$11.09
MLHG2	Growth & Energy with Color Enhancer	2.25 lbs.	6	317976	3 lbs.	\$23.19
MLHG6	Growth & Energy with Color Enhancer	5.25 lbs.	6	431220	7 lbs.	\$40.29
MLSF1	Summer Staple with Color Enhancer	10 oz.	12	37820	2 lbs.	\$10.09
MLSF2	Summer Staple with Color Enhancer	2 lbs.	6	717203	3 lbs.	\$22.19
MLSF6	Summer Staple with Color Enhancer	4.75 lbs.	6	531226	7 lbs.	\$40.29
MLSF17	Summer Staple with Color Enhancer	14 lbs.	2	554710	18 lbs.	\$70.59

IMMUNE STIMULANT FOOD With Montmorillonite Clay

This food has twice the levels of vitamins and also contains calcium clay which adds additional minerals providing immunity against viruses commonly found in pond environments.

- 36% protein, 6% fat
- Feed when water is over 68°F
- To be fed as supplemental food (four days a week) not as primary food
- Larger sizes sold as Summer Staple Food with Montmorillonite Clay



SUMMER STAPLE FOOD With Fruits & Greens

Koi absolutely swarm all over this food. Not to be used as primary diet but rather as treat. Made from apples, kiwi, apricots, peaches, pears, broccoli, cabbage, tomatoes, zucchini, spinach and more!

- 36% protein, 6% fat
- Will not cloud pond water
- Contains stabilized vitamin C



COLD WEATHER FOOD Wheat Germ

Ideal for feeding when water temperatures are below 55°F, contains less protein but more fat which koi require in cold weather.

- 32% protein, 7% fat
- Contains stabilized vitamin C



Part #	Description	Size	Case Quantity	Stocking Code	Ship Weight	List Price
MLIF12	Immune Stimulant with Montmorillonite Clay	10 oz.	12	87823	2 lbs.	\$10.09
MLIF22	Immune Stimulant with Montmorillonite Clay	1.75 lbs.	6	514870	3 lbs.	\$19.19
MLIF55	Immune Stimulant with Montmorillonite Clay	4.5 lbs.	6	231220	6 lbs.	\$40.29
MLFG1	Summer Staple with Fruits & Greens	10 oz.	12	58597	2 lbs.	\$11.09
MLFG2	Summer Staple with Fruits & Greens	2 lbs.	6	818754	3 lbs.	\$24.19
MLWG1	Cold Weather Food with Wheat Germ	12 oz.	12	47827	2 lbs.	\$10.09
MLWG3	Cold Weather Food with Wheat Germ	2.25 lbs.	6	717202	4 lbs.	\$22.19

Water Testing

POND & WATER GARDEN THERMOMETER

- Can be used as a floating thermometer (with cap on) or sinking (with cap off)
- Made from ABS plastic and shatterproof lens, reads in both F° and C°
- 3' cord included, twelve per case



P180

5-IN-1 TEST STRIPS

- Tests for nitrate, nitrite, total hardness, total alkalinity and pH
- 50 test strips in each bottle



TS5

MASTER LIQUID TEST KIT

- Complete kit for testing pond water levels of ammonia, nitrite, phosphate and pH
- Kit contains instructions, laminated color cards, four test tubes and holding tray



MTK

KOI MEDIC SALINITY METER

- Very accurate, easy to use salinity meter
- Simply turn on and dip into pond, LCD display will display salt content
- Auto shutoff, drop shock 6', 150 hr battery life, water resistant, low battery warning, 0.00 - 1.00% range 0.01 resolution, four 1.5v button cell batteries



KMS

HANNA ELECTRONIC PH/TEMPERATURE PENS

- Gives fast, accurate temperature and pH readings
- Battery level indicator and auto shutoff
- HPHS is a storage solution used to prolong electrode life



HPH

LIQUID PH TEST KIT

- Tests from 5.0-9.0
- Proper pH levels are needed for most water treatments to be effective
- 7.0 is neutral, desired range is from 6.0 to 8.0. 16+ tests



AQ160

PHOSPHATE TEST KIT

- Excess phosphates in pond water leads to excess algae growth!
- Use this simple test kit to monitor phosphate levels
- Performs 150 tests from 0-10 PPM phosphate levels



AQ63L

Water Quality Guidelines

Success with any aquatic system supporting fish depends on good water quality. Attributes of poor water quality are pH, ammonia, nitrite, dissolved oxygen levels and overly fluctuating water temperatures.

Desired Water Parameters:

- Hardness:** 100-300 ppm
- Dissolved Oxygen:** 8 ppm @ 70°F
- pH:** 7.2 to 8.3
- Temperature:** 65° to 80°F
- Salinity:** .1% to .25%
- Ammonia:** Less than .5 ppm
- Nitrite:** Less than .25 ppm

See www.easypropondproducts.com for more information

Part #	Description	Case Quantity	Stocking Code	Ship Weight	List Price
P180	Pond & Watergarden Thermometer	12	613344	1 lb.	\$17.79
KMS	Koi Medic Salinity Meter	—	576992	2 lbs.	\$109.99
HPH	Hanna pH/Temperature Pen	—	690014	1 lb.	\$128.59
HPHS	Hanna Storage Solution, 230 ml	—	413153	1 lb.	\$18.79
TS5	5 in 1 Test Strips	12	914564	1 lb.	\$18.79
MTK	Master Liquid Test Kit	12	322624	2 lbs.	\$36.19
AQ160	Liquid pH Test Kit	12	45246	1 lb.	\$8.39
AQ63L	Phosphate Test Kit	12	48996	1 lb.	\$14.39



Creating A Balanced Eco-System

EasyPro's line of water treatments is designed to make the care of your pond easy, effective and enjoyable. By eliminating the guess work and using simple dosages, EasyPro water treatments will keep your pond looking its best and provide a great home for fish and plants. The EasyPro water treatment line is proudly made in the USA.



Water Treatment Center



Save 15% on complete package

A water treatment package is available with all our best selling items. We have selected only those products which have shown a history of fast turnover to generate profits quickly. Buy this package and receive a four shelf display stand with banner FREE!

Package Includes:

Bacteria:

- (6) 16 oz. All Season Liquid Bacteria - ASB16
- (6) 32 oz. All Season Liquid Bacteria - ASB32
- (2) 128 oz. All Season Liquid Bacteria - ASB128
- (6) 12 ct. Sludge Remover Dry Bacteria - SRB12
- (4) 24 ct. Sludge Remover Dry Bacteria - SRB24

Barley Straw:

- (6) 16 oz. Barley Extract - BSE16
- (6) 32 oz. Barley Extract - BSE32
- (2) 128 oz. Barley Extract - BSE128

Rock & Waterfall Cleaner:

- (4) 2 lb. Rock & Waterfall Cleaner - OXY2
- (2) 8 lb. Rock & Waterfall Cleaner - OXY8

Conditioner:

- (6) 16 oz. Water Conditioner - CON16
- (6) 32 oz. Water Conditioner - CON32
- (2) 128 oz. Water Conditioner - CON128

Clarifier:

- (6) 16 oz. Clarifier - EWC16
- (6) 32 oz. Clarifier - EWC32
- (2) 128 oz. Clarifier - EWC128

Miscellaneous:

- (4) 10 lb. pails Salt - EPS10
- (6) 16 oz. Defoamer - DEF16
- (6) 16 oz. pH Up - EPHU16
- (6) 16 oz. pH Down - EPHD16
- (6) 16 oz. Pond Dye - PD16
- (50) Pond & Fish Care Brochure - PCF



Pond Care Brochure

Part #	Description	Stocking Code	Ship Weight	List Price
SC24WT	Water Treatment Package with Free Rack	41453968	pallet/310 lbs.	\$2236.89

All-In-One Pond Package

Combines the four most popular water treatments into one easy package

- Includes four 16 ounce bottles (one each) of Water Clarifier, Water Conditioner, All Season Bacteria and Liquid Barley Extract



Part #	Description	Case Quantity	Stocking Code	Ship Weight	List Price
WTP4	All-In-One Pack	4	738344	5 lbs.	\$58.99



Water Treatments



2 fl oz per
1,000 gallons

“ALL SEASON” LIQUID POND BACTERIA

- Works in water temperatures down to 45°F, allowing one product to work in Spring, Summer and Fall
- Removes ammonia, nitrites, nitrates, phosphates and sludge
- Enriched with barley
- Maintains a healthy, balanced ecosystem and reduces pond maintenance



Part #	Description	Size	Case Quantity	Stocking Code	Ship Weight	List Price
ASB16	All Season Liquid Bacteria - Pint	16 oz.	12	79551	2 lbs.	\$14.69
ASB32	All Season Liquid Bacteria - Quart	32 oz.	12	313516	3 lbs.	\$20.79
ASB128	All Season Liquid Bacteria - Gallon	128 oz.	4	245437	10 lbs.	\$69.89



2 fl oz per
1,000 gallons

LIQUID BARLEY STRAW EXTRACT

- All natural liquid formula - easier to use than pellets or bales
- Keeps water clean and clear
- Works faster than straw



Part #	Description	Size	Case Quantity	Stocking Code	Ship Weight	List Price
BSE16	Liquid Barley Straw Extract - Pint	16 oz.	12	311242	2 lbs.	\$17.29
BSE32	Liquid Barley Straw Extract - Quart	32 oz.	12	719621	3 lbs.	\$30.19
BSE128	Liquid Barley Straw Extract - Gallon	128 oz.	4	640814	10 lbs.	\$62.79



1 packet per
1000 gallons

SLUDGE REMOVER BACTERIA - DRY

- One ounce water soluble packets for easy application
- Removes sludge and odors
- Extends filter life between cleanings
- Recommended for ponds with gravel covered bottom where sludge can build up



Part #	Description	Size	Case Quantity	Stocking Code	Ship Weight	List Price
SRB12	Sludge Remover Bacteria - dry packets	12 ct	12	613512	1 lb.	\$20.79
SRB24	Sludge Remover Bacteria - dry packets	24 ct	12	320081	2 lbs.	\$30.89



1 lb per
300-400 sq ft

ROCK & WATERFALL CLEANER

- Quickly and effectively clean rocks, waterfalls, water features, fountains, statues, plant pots, etc.
- Powdered formula brings powerful oxygen based cleaning to large ponds or lakes as well as smaller koi ponds, water gardens and aquariums
- Great for use with fish, birds, pets and wildlife
- Lifts debris to pond surface where it can be removed by net or skimmer



Part #	Description	Size	Case Quantity	Stocking Code	Ship Weight	List Price
OXY2	Rock & Waterfall Cleaner	2 lbs.	12	513777	3 lbs.	\$21.19
OXY8	Rock & Waterfall Cleaner	8 lbs.	4	141400	9 lbs.	\$63.69



BARLEY STRAW BALES

- Each bale treats approximately 100 square feet of pond surface
- Lasts approximately three months

Part #	Description	Size	Case Quantity	Stocking Code	Ship Weight	List Price
EBS1	Barley Straw Bale	1 lb.	12	914626	2 lbs.	\$22.49

WATER CONDITIONER

- One of the most concentrated water conditioners on the market today
- Removes chlorine and destroys chloramines
- Detoxifies heavy metals



Part #	Description	Size	Case Quantity	Stocking Code	Ship Weight	List Price
CON16	Water Conditioner - Pint	16 oz.	12	211501	2 lbs.	\$17.69
CON32	Water Conditioner - Quart	32 oz.	12	621448	3 lbs.	\$32.99
CON128	Water Conditioner - Gallon	128 oz.	4	552459	10 lbs.	\$80.69



1 fl oz per 1,000 gallons



WATER CLARIFIER

- This food grade formula clears murky water fast
- Attracts suspended particles together allowing them to settle out of water column
- Best when used with EasyPro Pond Bacteria



Part #	Description	Size	Case Quantity	Stocking Code	Ship Weight	List Price
EWC16	Water Clarifier - Pint	16 oz.	12	711113	2 lbs.	\$17.09
EWC32	Water Clarifier - Quart	32 oz.	12	121834	3 lbs.	\$33.59
EWC128	Water Clarifier - Gallon	128 oz.	4	653032	10 lbs.	\$81.59



1 fl oz per 1,000 gallons



PH DOWN • PH UP

- Safe, effective way to control pH
- Treats fresh or salt water and is phosphate free
- Safe for use with fish and plants



Part #	Description	Size	Case Quantity	Stocking Code	Ship Weight	List Price
EPHU16	pH Up - Pint	16 oz.	12	17532	2 lbs.	\$11.59
EPHD16	pH Down - Pint	16 oz.	12	27538	2 lbs.	\$11.59
EPHD128	pH Down - Gallon	128 oz.	4	354207	10 lbs.	\$83.39



1 fl oz per 600 gallons



DEFOAMER

- Concentrated food grade formula
- Can be used in water gardens, koi ponds, fish hauling trucks, etc.

Part #	Description	Size	Case Quantity	Stocking Code	Ship Weight	List Price
DEF16	Defoamer - Pint	16 oz.	12	912600	2 lbs.	\$19.39
DEF128	Defoamer - Gallon	128 oz.	4	554205	10 lbs.	\$83.39



1 fl oz per 1,000 gallons



BLUE POND DYE

- Helps filter out sunlight as well as give pond water a pleasing "natural blue" appearance
- Does not stain or harm fish, plants or other wildlife once dispersed in water
- Concentrated formula - use one ounce per 1000 gallons of water!

Part #	Description	Size	Case Quantity	Stocking Code	Ship Weight	List Price
PD16	Blue Pond Dye - Pint	16 oz.	12	216245	2 lbs.	\$24.99

1 fl oz per 1,000 gallons





POND SALT

- Use one to two pounds per 100 gallons, three pounds per 100 gallons when treating for disease
- 99% pure-made from evaporated seawater, will not harm plants
- Reduces fish stress and improves disease recovery



Part #	Description	Size	Case Quantity	Stocking Code	Ship Weight	List Price
EPS10	Pond Salt	10 lb. Pail	6	611374	12 lbs.	\$17.49
EPS20	Pond Salt	20 lb. Pail	4	315595	23 lbs.	\$23.99
EPS50	Pond Salt	50 lb. Pail	2	425997	54 lbs.	\$39.99
EPS50B	Pond Salt	50 lb. Box	2	119492	52 lbs.	\$29.99



PREMIUM ACTIVATED CARBON

- Has the natural ability to absorb high amounts of organic solids and medications used on fish
- Has also been shown to have the ability to remove tannins that cause “tea-colored” water
- Use approximately 1½ cupfuls for every 100 gallons of pond water, replace every four to five weeks as needed

Part #	Description	Size	Case Quantity	Stocking Code	Ship Weight	List Price
AC8	Premium Activated Carbon	8 lb. Pail	4	255701	9 lbs.	\$85.69
AC25	Premium Activated Carbon	25 lb. Pail	2	2148136	29 lbs.	\$227.89
AC50	Premium Activated Carbon	50 lb. Box	2	4259998	52 lbs.	\$399.99



Aquatic Products

AQUATIC PLANT FERTILIZER TABS

- 10-14-8 formula keeps your plants vigorous and beautiful all season long
- Use one tablet per gallon of soil each month during growing season
- Registered for use in all 50 states!

APHID CONTROL

- Keeps insects off aquatic and terrestrial plants for seven days, is safe for all aquatic life and pets
- Repels aphids, mosquitoes, ticks, gnats, earwigs, crickets and other bugs, also repels deer
- 12 ounce spray bottle



SPARKLE FOUNTAIN CLEANER

- Rapidly cleans fountains, basalt rocks and statuary
- Helps prevent stains, sludge and mineral deposits from forming
- Eight ounce bottle treats 80 gallons of water

Part #	Description	Size	Case Quantity	Stocking Code	Ship Weight	List Price
APH12	Aphid Control	12 oz.	12	213643	2 lbs.	\$19.49
SFC8	Sparkle Fountain Cleaner	8 oz.	12	67974	1 lbs.	\$11.39
APF60	Aquatic Plant Fertilizer	60 ct	12	311121	2 lbs.	\$15.89
APF900	Aquatic Plant Fertilizer	900 ct	2	9127880	10 lbs.	\$182.69

GreenClean Granular Algaecide

Ideal string algae control in ponds, waterfalls, fountains and streams

GreenClean Granular works through oxidation, breaking down algae cells on contact. Dead matter floats to the surface where it is removed by a skimmer or a net. It is ideal for use with bacteria. Once it kills algae, bacteria go to work cleaning up organic material.

Features & Benefits:

- Kills algae on contact — visible results in minutes
- For use in water features containing live fish and plants
- Effective, eco-friendly chemistry — no copper residue
- Controls string algae in ponds, streams or waterfalls
- EPA registered
- Organic Materials Review Institute (ORMI) listed

Use 1/2 pound (1 cup) per 1000 gallons of water to control existing problems, use 1/4 pound (1/2 cup) per 1000 gallons as maintenance dosage



Application Tips for Green Clean Granular

1. Apply early in the morning on clear sunny day
2. Turn off circulation
3. Apply to affected areas, including waterfalls and streams
4. Turn circulation back on after 10-20 minutes
5. Skimming/netting dead algae can help prevent further algae

Note: Always read and follow label directions

Part #	Description	Size	Treats Up To	Case Quantity	Stocking Code	Ship Weight	List Price
GC2	GreenClean Granular	2.5 lbs.	5000 gallons	12	221224	3 lbs.	\$28.29
GC8	GreenClean Granular	8 lbs.	16000 gallons	4	645821	9 lbs.	\$61.09
GC20**	GreenClean Granular	20 lbs.	7 acre ft	—	474473	24 lbs.	\$99.29
GC50**	GreenClean Granular	50 lbs.	17 acre ft	—	8143027	55 lbs.	\$190.69

**Does not qualify for case discount

GreenClean Liquid Algaecide

Commercial strength liquid algaecide for treatment and control of algae conditions in water features

Activated peroxygen formula is chlorine, copper and phosphate free. GreenCleanFX controls algae blooms and clears green water.

Features & Benefits:

- Fast acting algae control
- Reduces organic build-up and noxious odors
- For use in water features containing live fish and plants
- Does not affect pH levels
- Tip 'n' pour container for easy and precise dosing
- Low application rates for better coverage



Application Tips for Green Clean FX Liquid

1. Apply early in the morning on clear sunny day
2. Be sure pH is between 7.0 and 8.0, adjust if needed
3. Apply to area with most active flow or water movement for adequate mixing
4. Leave pump or aeration running continuously during treatment for 48 hours
5. Remove dead algae after treatment to help lessen load of decaying organic matter in the pond

Note: Always read and follow label directions

Problem pond: one ounce per 150 gallons • Preventative: one ounce per 300 gallons

Part #	Description	Size	Treats Up To	Case Quantity	Stocking Code	Ship Weight	List Price
GCL16	GreenClean FX Liquid	17 oz.	5100 gallons	12	915590	2 lbs.	\$20.79
GCL32	GreenClean FX Liquid	33 oz.	9900 gallons	12	223693	3 lbs.	\$31.59
GCL128	GreenClean FX Liquid	128 oz.	38400 gallons	4	547477	10 lbs.	\$63.29

For weed & algae control in larger ponds and lakes, contact us for our Lake & Pond Management catalog!



MICROBE-LIFT BACTERIA



- 100% natural, safe and beneficial bacteria and will not harm fish or plants
- Reduces ammonia, nitrogen levels and noxious odors and improves dissolved oxygen levels
- Dissolves away organic sludge and slime
- Microbe-Lift Bacteria works in water temperatures below 55° but will not be harmed if frozen; bacteria will retain viability after thawing

Part #	Description	Size	Case Quantity	Stocking Code	Ship Weight	List Price
MLBP	Microbe-Lift Bacteria - Pint	16 oz.	12	614104	2 lbs.	\$18.19
MLBQ	Microbe-Lift Bacteria - Quart	32 oz.	12	821073	3 lbs.	\$27.19
MLBG	Microbe-Lift Bacteria - Gallon	128 oz.	6	262531	10 lbs.	\$80.69



PROFESSIONAL BLEND MICROBE-LIFT BACTERIA

Maintains a healthy environment for pond, fish and plants all in one treatment!

- Allows for treatment of all the areas of water quality in one easy step
- Ideal for pond maintenance companies - eliminates the need for multiple bottles of product

Part #	Description	Size	Case Quantity	Stocking Code	Ship Weight	List Price
PBLQ	Professional Blend Bacteria - Quart	32 oz.	12	418751	2 lbs.	\$24.19
PBLG	Professional Blend Bacteria - Gallon	128 oz.	6	757034	11 lbs.	\$73.59



MICROBE-LIFT SLUDGE AWAY

Great Product!

Microbe-Lift Sludge Away is a special blend of bacteria specifically designed to remove sludge, this is especially helpful in ponds that have rock bottoms.

- Binds phosphates and helps improve pond clarity
- 100% active ingredients that disperse quickly

Part #	Description	Size	Case Quantity	Stocking Code	Ship Weight	List Price
MLSQ	Sludge Away - Quart	32 oz.	12	225021	2 lbs.	\$32.29
MLSG	Sludge Away - Gallon	128 oz.	6	362531	11 lbs.	\$80.69

BARLEY STRAW PELLETS

100% natural product of concentrated barley straw!

- Buffer pH and reduces phosphorous levels in pond water
- Dissolves quickly and is safe for use with all other bacteria products
- Includes added peat and humates
- Completely harmless to fish, plants and other pond treatments



Part #	Description	Size	Case Quantity	Stocking Code	Ship Weight	List Price
BP22	Barley Straw Pellets - Zipper Bag	2.2 lbs.	12	413243	3 lbs.	\$17.09
BP44	Barley Straw Pellets - Zipper Bag	4.4 lbs.	12	920304	5 lbs.	\$26.19
BP105	Barley Straw Pellets - Zipper Bag	10.5 lbs.	6	629675	12 lbs.	\$38.29
BP400	Barley Straw Pellets - Bulk Bag	40 lbs.	2	298423	43 lbs.	\$126.99

LIQUID BARLEY EXTRACT

- Easy to use with a built in measuring cup, decomposition process starts immediately
- Not harmful to humans, fish, plants or pets
- Concentrated — one bottle is equal to multiple bales of barley straw



Part #	Description	Size	Case Quantity	Stocking Code	Ship Weight	List Price
BE8	Liquid Barley Extract	8 oz.	12	79375	1 lb.	\$12.09
BE16	Liquid Barley Extract	16 oz.	6	212471	2 lbs.	\$16.09
BE32	Liquid Barley Extract	32 oz.	6	621854	3 lbs.	\$28.19
BE64	Liquid Barley Extract	64 oz.	4	838282	5 lbs.	\$49.39

ALGAWAY 5.4 ALGAECIDE

- EPA registered, 1 oz treats 350 gallons of pond water, safe to use with fish and aquatic plants



Part #	Description	Size	Case Quantity	Stocking Code	Ship Weight	List Price
ALG8	Algaway 5.4	8 oz.	12	37438	1 lb.	\$9.59
ALG16	Algaway 5.4	16 oz.	12	911387	2 lbs.	\$14.69
ALG32	Algaway 5.4	32 oz.	12	817974	3 lbs.	\$23.19
ALG128	Algaway 5.4	128 oz.	4	262536	10 lbs.	\$80.69



ALGAWAY 60

- EPA registered algae control for ponds, formal fountains, Just-A-Falls and other bodies of water not containing fish or plants, safe for irrigation, turf and shrubs
- Not for use in waters containing fish or aquatic plants**
- One ounce treats up to 1000 gallons of water

Part #	Description	Size	Case Quantity	Stocking Code	Ship Weight	List Price
ALG60Q	Algaway 60	32 oz.	12	132774	3 lbs.	\$42.29
ALG60G	Algaway 60	128 oz.	4	5125003	10 lbs.	\$161.29



SPRING/SUMMER CLEANER

- Accelerate the breakdown of leaves, twigs and other accumulated dead organic waste
- Helps to jump start your pond to a healthier environment in the spring
- Each box contains eight 2 oz. water soluble packets of cellulase enzymes and cellulase producing bacteria

Part #	Description	Size	Case Quantity	Stocking Code	Ship Weight	List Price
MLSC	Spring/Summer Cleaner	1 lb.	12	321851	3 lbs.	\$28.19



AUTUMN PREP

- Helps accelerate decomposition during the fall and winter months, will also jump start your pond to a healthier environment in the spring
- Quart packages contain one quart of liquid bacteria and two 2 oz. water soluble packets with a blend of cellulase enzymes, cellulase producing bacteria and a cold weather bacteria
- Gallon kits are ideal for treating large ponds, these kits include one gallon of liquid bacteria and eight 2 ounce water soluble packets

Part #	Description	Size	Case Quantity	Stocking Code	Ship Weight	List Price
MLAP	Autumn Prep - Quart	32 oz.	12	324256	3 lbs.	\$31.29
MLAK	Autumn Prep - Gallon	128 oz.	4	778112	10 lbs.	\$100.79



AQUATIC PLANTING MEDIA

- Kiln fired, will not break down, float or cloud pond water
- All inert ingredients that retain oxygen and is safe for all fish and plants
- 10% natural minerals, containing no algae promoting nutrients, fertilizer, peat or compost

Part #	Description	Size	Case Quantity	Stocking Code	Ship Weight	List Price
APM10	Aquatic Planting Media	10 lbs.	6	411691	11 lbs.	\$15.09
APM20	Aquatic Planting Media	20 lbs.	3	717976	22 lbs.	\$23.19



BROAD SPECTRUM DISEASE TREATMENT

- The premier product in the field of disease treatment because it is formulated with malachite green chloride instead of the more toxic oxalate salt
- The most effective treatment for the control of diseases caused by ich, costia, trichodina, chilodonella, oodinium and fungal infections

Part #	Description	Size	Case Quantity	Stocking Code	Ship Weight	List Price
BSDT16	Broad Spectrum Disease Treatment	16 oz.	12	210144	2 lbs.	\$13.09
BSDT32	Broad Spectrum Disease Treatment	32 oz.	12	619525	3 lbs.	\$25.19





ALGAEFIX®

SAVE
5%
ON A CASE

EPA registered algae control for water gardens! Control algae without harming fish or plants! Controls “green water algae”, string algae and blanket weed. Also kills existing algae and controls future algae blooms.

Part #	Description	Size	Case Quantity	Stocking Code	Ship Weight	List Price
AF8	AlgaeFix®, Treats 2,400 gallons	8 oz.	12	87492	1 lb.	\$11.99
AF16	AlgaeFix®, Treats 4,800 gallons	16 oz.	12	111184	2 lbs.	\$17.89
AF32	AlgaeFix®, Treats 9,600 gallons	32 oz.	6	418813	3 lbs.	\$30.09
AF64	AlgaeFix®, Treats 19,200 gallons	64 oz.	6	633563	5 lbs.	\$53.69
AF128	AlgaeFix®, Treats 38,400 gallons	128 oz.	4	157373	10 lbs.	\$91.79
AF320	AlgaeFix®, Treats 96,000 gallons	320 oz.	2	6104183	22 lbs.	\$166.69



ECOFIX®

- Increases oxygen levels, ideal for use with AlgaeFix®, breaks down dead algae

Part #	Description	Size	Case Quantity	Stocking Code	Ship Weight	List Price
EF16	EcoFix®, Treats 4,000 gallons	16 oz.	12	711181	2 lbs.	\$17.89
EF64	EcoFix®, Treats 16,000 gallons	64 oz.	6	633371	5 lbs.	\$53.39



MELAFIX®

- Treats ulcers and open wounds or use to rapidly repair damaged fins
- Safe for aquatic plants and will NOT affect the biological filter or alter pH

Part #	Description	Size	Case Quantity	Stocking Code	Ship Weight	List Price
MF16	MelaFix®, Treats 4,800 gallons	16 oz.	12	811624	2 lbs.	\$18.59
MF64	MelaFix®, Treats 19,000 gallons	64 oz.	4	140246	5 lbs.	\$64.39



PIMAFIX®

- Effectively clears fungal infections and treats the underlying cause of infection
- Can be used in combination with PondCare MelaFix® to treat a wide range of fungal and bacterial infections

Part #	Description	Size	Case Quantity	Stocking Code	Ship Weight	List Price
PF16	PimaFix®, Treats 2,365 gallons	16 oz.	12	812741	2 lbs.	\$20.39
PF64	PimaFix®, Treats 9,600 gallons	64 oz.	4	142125	5 lbs.	\$67.39



STRESS COAT®

Fish & Water Conditioner

- Replaces the natural mucous slime coating on the skin of pond fish when it has been damaged
- Removes chlorine and breaks the chloramine bond, also contains aloe vera to help heal wounds and torn fins

Part #	Description	Size	Case Quantity	Stocking Code	Ship Weight	List Price
SC16	Stress Coat®, Treats 1,920 gallons	16 oz.	12	610181	2 lbs.	\$16.29
SC64	Stress Coat®, Treats 7,680 gallons	64 oz.	6	229873	5 lbs.	\$47.79



On the following pages you will find various types of media, designed for removing solid particles from the water or creating large surface areas on which beneficial bacteria colonize. Our media can be used by do-it-yourselfers to build their own filters or as replacement media for existing filters. The key to good water quality is proper filtration.

Ponds that are under filtered will likely be cloudy, green and unattractive. Likewise aquatic systems that do not have properly sized filters can have high ammonia, high nitrites and low feed conversions.

In addition to good biological filtration, a UV sterilizer is another good option in many cases. A UV uses high intensity light to destroy algae cells that cause green water. They also eliminate disease causing pathogens, protecting fish health. A properly designed filtration system is vital to the success of any water system. Please feel free to contact us for technical and design assistance.



Roll of PFM3

Solids Filter Material

Save money — cut your own filter pads!

Bulk medias that can easily be cut to fit popular brands of skimmers, pressure filters, waterfall filter boxes or pump pre-filters

- PFM3-5 material is made from long lasting polyester — can be rinsed clean and reused over and over
- Most commonly used as a solids filter material before water enters biological media (page 76)
- For maximum savings buy full rolls and cut to length as needed



PFM1

- Blue and white material bonded together, easy to cut
- Average life - one season
- Fairly dense - removes fine particles

PFM3

- 1" medium density, lime green
- Removes fine particles, cuts easily
- Ideal for replacement media in small pumps and pre-filters
- Average life - 2 to 3 years

PFM4

- 1" coarse density, off white
- Removes medium to large particles, cuts easily
- Ideal for higher flow
- Average life - 2 to 3 years

PFM5

- 2" coarse density, off white
- Used in waterfall filter boxes
- 56" wide roll for large jobs
- Average life - 2 to 3 years



Part #	Description	Thickness x Width x Length	UPS-able	Stocking Code	Ship Weight	List Price
PFM1	Bonded Filter Material	3/4" x 24" x per yard	Yes	17473	2 lbs.	\$11.49
PFM1R	Bonded Filter Material	3/4" x 24" x 30 yard roll	Yes	7194675	12 lbs.	\$299.49
PFM3	Medium Density	1" x 28" x per yard	11 Yard Max.	915582	3 lbs.	\$23.99
PFM3B*	Medium Density	1" x 28" x 6 yard box	yes	493506	10 lbs.	\$143.99
PFM3R	Medium Density	1" x 28" x 40 yard roll	no	2529818	77 lbs.	\$815.09
PFM4	Coarse Density	1" x 28" x per yard	11 Yard Max.	315512	4 lbs.	\$23.89
PFM4B*	Coarse Density	1" x 28" x 6 yard box	yes	993047	10 lbs.	\$143.39
PFM4R	Coarse Density	1" x 28" x 40 yard roll	no	3527215	78 lbs.	\$811.09
PFM5	Coarse Density	2" x 28" x per yard	6 Yard Max.	219671	5 lbs.	\$30.29
PFM5B*	Coarse Density	2" x 28" x 6 yard box	yes	8118000	17 lbs.	\$181.79
PFM5R	Coarse Density	2" x 28" x 30 yard roll	no	4530986	90 lbs.	\$816.89
PFM5F	Coarse Density	2" x 56" x 30 yard roll	no	2986959	105 lbs.	\$1518.39

Matala®

BIOLOGICAL PREFILTER

- Use on all brands of mag drive submersible pumps as well as small external pumps to prevent plugging
- Made from durable Matala filter media for years of use
- Can be connected to each other end to end for increased capacity
- Dual filter media (green and blue) for complete mechanical and some biological filtration
- 1", 1 1/4" and 1 1/2" hose tails included, fitting on filter is 1 1/2" female pipe thread
- Maximum flow rate: 1900 GPH on BIO11 and 3400 GPH on BIO20

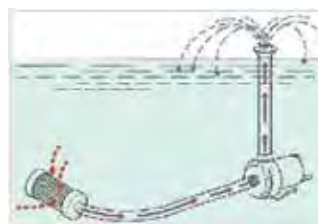

BIO11



BIO20

Part #	Description	Case Quantity	Stocking Code	Ship Weight	List Price
BIO11	Prefilter, Small - 4" x 8"	18	121815	2 lbs.	\$34.89
BIO20	Prefilter, Large - 8" x 8"	8	234496	4 lbs.	\$55.19

Our Lowest Cost Media!

MADE IN THE USA



BIO-BLOX FILTER MEDIA

EasyPro grinds this media in-house, allowing us to offer very competitive pricing

- Great low-cost choice for large volume applications
- Approximately 500 square feet of surface area in every cubic foot of material, this allows for maximum filtration in a given area
- Polyester material will last for years
- Available in a one, ten or twenty five cubic foot box and also in 2 cu. ft. pre-filled mesh bags

Part #	Description	Stocking Code	Ship Weight	List Price
BBM05	Bio-Blox, 1/3 cubic foot - box	710390	2 lbs.	\$15.99
BBM1	Bio-Blox, one cubic foot - box	212996	4 lbs.	\$19.99
BBM10	Bio-Blox, ten cubic feet - box	3111794	50 lbs.	\$171.99
BBM25	Bio-Blox, 25 cubic feet - box	8186931	130 lbs.	\$287.59
BBM2B	Bio-Blox, two cubic feet - mesh bag	532499	8 lbs.	\$49.99

FILTER FLOSS BIO-MEDIA

Flat strapping embossed on both sides creating additional surface area for bacteria

- Light weight ribbon type material commonly used in our AquaFalls pond filters
- Each box fills three MB21 mesh bags (page 55) and contains approximately 6 cu. ft. of media
- Save 5% when ordering in case quantities, six per case
- Also available in 2 cu. ft. pre-filled mesh bags

SAVE 5% ON A CASE!

Part #	Description	Stocking Code	Ship Weight	List Price
FFM	Filter Floss Bio-Media, 3000' roll	632068	9 lbs.	\$47.49
FFM2B	MB21 Media Bag with 1/3 roll Filter Floss	526290	4 lbs.	\$37.59



BIO-BALLS

These plastic Bio-Balls are a great media for use in all types of filters

- Can be used as a loose media or put in mesh bags (see page 55) for easy removal and cleaning
- Will not compact like other soft media, reduces channeling of water around media
- 1 1/2" in diameter, black in color - approximately 660 pieces per cubic foot

ups *Dimensional rates apply on BB15B

Part #	Description	Stocking Code	Ship Weight	List Price
BB05	Bio-Balls, approximately 200 ct box	319495	3 lbs.	\$29.99
BB15	Bio-Balls, one cubic foot	432491	12 lbs.	\$49.99
BB15B*	Bio-Balls, 4.5 cubic feet	7139872	38 lbs.	\$215.19



ULTIMATE TUBE MEDIA

Contains nearly 500 square feet of surface area in every cubic foot of media

- Round media with multiple internal baffles which create tremendous additional surface area
- Media included in EasyPro bead filters on page 79

ups *Dimensional rates apply on UTM10

Part #	Description	Stocking Code	Ship Weight	List Price
UTM1	Ultimate Tube Media, one cubic foot	139710	11 lbs.	\$61.09
UTM10*	Ultimate Tube Media, ten cubic feet	6383565	105 lbs.	\$590.09
UTM25	Ultimate Tube Media, 25 cubic feet	2892643	180 lbs.	\$1373.29



Bacti-Twist™ PLASTIC BIOFILTER MEDIA

- Black, spiral shaped plastic media that is designed for both biological and mechanical filtration
- Comes inside a black nylon mesh bag, this makes for easy cleaning and handling
- Ideal for use in AquaFalls filters and can be used inside our spillways for biological filtration

Part #	Description	Stocking Code	Ship Weight	List Price
BTM1	1 cubic foot Bag	623913	2 lbs.	\$36.79
BTM2	2 cubic feet Bag	346277	4 lbs.	\$71.19
BTM5	5 cubic feet Bag	8111604	10 lbs.	\$171.69



MADE IN THE USA

Matala® FILTRATION MEDIA

EasyPro is pleased to offer Matala filter media! This media is the finest biological media available and although it costs a little more – it will outlast all other similar products!



Matala is available in four different densities for various types of filtration:

- **Black:** Very coarse, open weave – good for high flow applications
- **Green:** Coarse, semi-open weave – allows good flow yet filters well
- **Blue:** Medium, fairly dense weave – traps a lot of debris, medium flow
- **Gray:** Fine, dense weave – lower flow but thorough filtration

Easy to cut into custom sizes or shapes!

Matala is sold in two sizes of flat sheets:

- Half sheets - 39" x 24" - can ship UPS
- Full sheets - 39" x 48" - can be folded in half to ship UPS dimensional rates or must ship via freight when flat, folding may leave a small crease in media but will not affect filtering



For best results mix layers of Matala using a coarse layer first for large solids removal followed by denser layers for fine debris. Due to its unique material design, Matala media is much more rigid than traditional polyester media. This makes it easier to clean but does not allow it to be rolled up like other media.

Part #	Description	Case Quantity	Stocking Code	Ship Weight	List Price
MBK48	Full Sheet Black Material	5	243433	8 lbs.	\$69.49
MGN48	Full Sheet Green Material	5	845187	9 lbs.	\$72.29
MBE48	Full Sheet Blue Material	5	446371	9 lbs.	\$74.19
MGY48	Full Sheet Gray Material	5	752872	10 lbs.	\$84.59
MBK24	Half Sheet Black Material	10	321684	4 lbs.	\$34.69
MGN24	Half Sheet Green Material	10	622628	5 lbs.	\$36.19
MBE24	Half Sheet Blue Material	10	923181	5 lbs.	\$37.09
MGY24	Half Sheet Gray Material	10	326432	6 lbs.	\$42.29

Matala® BIO-STEPS FILTERS

- Gravity flow filter with four stages of progressive filtration
- Optional 9 watt UV - inserts easily into unit for superior water clarity!
- Measures 23" x 12½" x 20"H
- 1½" outlet
- 1", 1¼" and 1½" multi step inlet
- Sloped bottom with sludge drain for easy cleaning
- Effective mechanical and biological filtration for ponds up to 2700 gallons (lower if high fish loads)
- Shown with optional waterfall outlet



Part #	Description	Stocking Code	Ship Weight	List Price
MBS10	Bio-Step Filter	9139525	20 lbs.	\$206.69
MBS10U	9 watt UV Kit	394166	4 lbs.	\$139.49
MBS10W	Waterfall Outlet	829834	3 lbs.	\$45.89

Matala® FILTER BRUSHES

Filter brushes have long been used in the koi industry as a great filter media. Brushes will collect large amounts of debris yet will not restrict water flow even when dirty. Filter brushes work well for both solids removal and biological filtration. Available 15" or 23" long and can be cut down in length if needed.

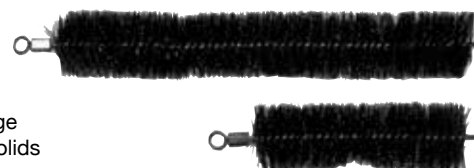

Part #	Description	Case Quantity	Stocking Code	Ship Weight	List Price
FB15	Filter Brush, 15"	12	76183	1 lb.	\$9.89
FB23	Filter Brush, 23"	12	48127	2 lbs.	\$12.99



Pressurized Filters

EasyPro is pleased to offer these high quality, low cost pressure filters! Ideal for pre-formed ponds and other small water features needing effective filtration with minimal investment.

- Sturdy filter housings — can be buried up to cleaning ring for easy concealment
- Optional built-in UV for crystal clear water
- Dual filtration — filter pads collect solid debris while bio-media provides excellent biological filtration
- Cleaning indicator — spring loaded indicator shows when filter needs to be cleaned
- Easy to clean — filters are easy to disassemble & clean, makes maintenance a snap!
- Multi step connectors — inlet/outlet fittings accept a variety of tubing sizes

Part #	Max Pond Size	UV/Watts	Inlet/Outlet Sizes	Recommended Maximum GPH Flow	Stocking Code	Ship Weight	List Price
ECF10	1000 Gallons	No	1/2", 3/4", 1"	600	1107503	10 lbs.	\$165.39
ECF10U	1000 Gallons	Yes/7	1/2", 3/4", 1"	600	2192986	11 lbs.	\$296.89
ECF25	2500 Gallons	No	3/4", 1", 1 1/4", 1 1/2"	1350	7174262	14 lbs.	\$268.09
ECF25U	2500 Gallons	Yes/9	3/4", 1", 1 1/4", 1 1/2"	1350	4253305	18 lbs.	\$389.69
ECF40	4000 Gallons	No	3/4", 1", 1 1/4", 1 1/2"	2000	8223270	15 lbs.	\$343.49
ECF40U	4000 Gallons	Yes/13	3/4", 1", 1 1/4", 1 1/2"	2000	2316352	20 lbs.	\$486.69

Filter Parts



REPLACEMENT FILTER PAD SETS

Part #	Description	Stocking Code	List Price
ECF10F	For ECF10 units	416769	\$25.79
ECF25F	For ECF25 & 40 units	334571	\$53.19



INLET/OUTLET HOSE BARB SET

BARB1	For ECF10, 10U	69618	\$14.79
BARB2	For ECF25 & 40 Units	410852	\$16.69

REPLACEMENT UV BULBS, SLEEVES

Part #	Description	Stocking Code	List Price
10UB	7 watt Bulb	533216	\$51.09
10US	7 watt Sleeve	844970	\$69.19
25UB	9 watt Bulb	436787	\$56.59
25US	9 watt Sleeve	949073	\$75.49
40UB	13 watt Bulb	139512	\$60.79
40US	13 watt Sleeve	249395	\$75.99



Submersible Pump/Filter/UV Combo

Combines pump, filter, UV and fountain into one complete unit. Ideal for small and pre-formed ponds needing simple effective filtration.

- Eleven watt UV for crystal clear water
- 675 GPH pump with 20' power cord, 48 watts
- Mechanical and biological filtration media included
- One year warranty
- Swivel joint for easy leveling of fountain nozzles



REPLACEMENT PARTS FOR ESF1250

Part #	Description	Stocking Code	List Price
ESF1250B	UV Bulb	829692	\$39.59
ESF1250S	UV Sleeve	423327	\$31.09
ESF1250F	Filter Pad & Media	015891	\$21.19
ESF1250I	Impeller for Pump	214775	\$19.69

Includes three fountain nozzles and diverter valve

Part #	Max Pond Size	UV/Watts	Recommended Maximum GPH Flow	Stocking Code	Ship Weight	List Price
ESF1250	1250 Gallon	11	675	3155997	11 lbs.	\$239.99

Pressurized Bead Filters

EasyPro pressurized filters offer mechanical and biological filtration for water gardens, koi ponds and hybrid ponds.

Filter Features:

- Uses seven position control head
- Strong fiberglass reinforced filter body
- Can be buried up to control head for easier concealment
- Ultimate Tube Media included for maximum filtration and minimal back pressure
- Models **PBF15** through **PBF250** have a clear section in the waste line to easily monitor cleaning cycle
- Simple to set up and assemble
- Great filters for fish display systems
- Free unions included for all plumbing lines on **PBF15** through **PBF250**

Three new side mount filters are now available for ponds up to 60,000 gallons

- 3" inlet/outlet allows for higher flow rates
- Convenient bottom drain port for easy sludge removal between back flushes



Ultimate Tube Media (included)



Optional Upgrades:

AIR BLOWER

Using a blower to agitate the media inside the filter prior to backflush will greatly speed up the process and reduce the amount of water loss.

Package includes 115 volt, 1.5 HP blower, check valve/ball valve, bulkhead fitting, internal diffuser pipe and PVC fittings.

Blower kits bought with filter will have bulkhead installed in filter tank. Blower kits bought separately from filter will require installation in the field.



Part # ABK15

AUTOMATED BACKFLUSH

Creates a totally maintenance free filter system!

This automatic backflush system totally eliminates maintenance of the filtration system! Computerized system will shut off pump, rotate filter head to backflush, turn on pump to clean filter then reverse the process back to filter mode and restart pump.



Part # PBAC61 or PBAC62

Part #	Max Pond Size	Diameter x Height*	Inlet/Outlet Size	Max GPM†	Stocking Code	Ship Weight	List Price
PBF15	1500 Gallons	17" x 27"	1 1/2"	30	4482169	17 + 21 lbs.	\$741.79
PBF35	3500 Gallons	21" x 35"	1 1/2"	50	7703551	36 + 26 lbs.	\$1082.39
PBF55	5500 Gallons	22" x 35"	1 1/2"	70	3994438	45 + 40 lbs.	\$1529.89
PBF90	9000 Gallons	28" x 37"	2"	90	61246822	110 lbs.	\$1918.19
PBF150	15000 Gallons	30" x 39"	2"	100	51675430	150 lbs.	\$2577.59
PBF250	25000 Gallons	36" x 46"	2"	115	91892661	190 lbs.	\$2911.79
PBF300S	30000 Gallons	36" x 40"***	3"	225	62674296	200 lbs.	\$4114.29
PBF450S	45000 Gallons	42" x 46"***	3"	225	33410675	270 lbs.	\$5247.19
PBF600S	60000 Gallons	48" x 52"***	3"	225	84217971	315 lbs.	\$6489.19
PBAC61	Automated Backflush System for 1 1/2" units	-	-	-	21385993	6 lbs.	\$1979.99
PBAC62	Automated Backflush System for 2" units	-	-	-	81490994	6 lbs.	\$2129.99
ABK15	Air Blower Backflush Assist Package	-	-	-	1301987	12 lbs.	\$464.59

*Height is measured from floor to top of handle **Diameter measurement is tank only, control valve not included

†Higher flow rates are possible but filter effectiveness is reduced



UV Clarifiers



EasyPro offers a line of high quality, affordable UV clarifiers

- True quartz glass sleeve — not plastic like some other brands
- Multistep connectors for 3/4", 1" and 1 1/4" tubing
- Dual outlets - choose which side of the UV is easiest for your plumbing layout! Outlet can be on same side as inlet or opposite side.
- Tough, impact resistant housings
- Weatherproof ballasts with 15' power cord
- Long lasting bulbs

Part #	Watts	Max. Flow GPH	Max. Pond Size	Stocking Code	Ship Weight	List Price
EPU18N	18	2100	4000 gallons	6154175	7 lbs.	\$237.19
EPU36N	36	3900	7000 gallons	3220862	9 lbs.	\$339.79

EASYPRO UV REPLACEMENT PARTS:



Part #	Description	Stocking Code	Ship Weight	List Price
EP18BN	18w Bulb	437637	2 lbs.	\$57.89
EP36BN	36w Bulb	748615	2 lbs.	\$74.79
EP18SN	18w Sleeve	557652	3 lbs.	\$88.69
EP36SN	36w Sleeve	864730	3 lbs.	\$99.59



Matala[®] STAINLESS STEEL UV CLARIFIERS

- Heavy duty 304 stainless steel body will last a lifetime!
- LED display indicates when unit needs service
- Up to 9000 hour bulb life
- 2" male threaded outlets
- 3 year warranty on housing

Part #	Watts	Max. Flow	Max Pond Size (gal.)	Lamp Size	Stocking Code	Ship Weight	List Price
MSU40	40	1800 GPH	5500	40w	9475872	15 lbs.	\$704.99
MSU75	75	3600 GPH	10000	75w	6586645	20 lbs.	\$869.09
MSU150	150	6500 GPH	19000	2-75w	3930620	25 lbs.	\$1378.69
MSU300	300	12000 GPH	30000	4-75w	11565454	42 lbs.	\$2319.19

MATALA UV REPLACEMENT PARTS:

Part #	Description	Stocking Code	Ship Weight	List Price	Part #	Description	Stocking Code	Ship Weight	List Price
MSUS	Quartz Sleeve (all models)	146916	3 lbs.	\$69.49	MSU40T	40w Transformer	273974	2 lbs.	\$109.59
MSU40B	40w Bulb	745692	2 lbs.	\$67.69	MSU75T	75w Transformer	592540	3 lbs.	\$137.09
MSU75B	75w Bulb	671145	2 lbs.	\$105.39	MSU150T	150w Transformer	9110421	5 lbs.	\$163.59
MSUO	"O" Ring (all models)	32698	1 lb.	\$3.99					

UV Clarifiers — How do they work?

A common way to keep pond water clear is the use of a UV clarifier. If using a high quality biological filter that is capable of filtering your size pond and fish load, a UV will not likely be needed. If the filter is not capable of filtering the pond, there will be excess nutrients in the water and there will likely be a green water algae problem. UV clarifiers work by passing water through a tube next to a UV bulb. The high intensity light kills off the microscopic algae cells that form green water. Make no mistake, a UV will not control string algae since the string algae does not flow through the tube next to the light bulb.

Some manufacturers call their units UV sterilizers. The difference between a UV clarifier and a UV sterilizer is how fast the water flows through the tube. Algae cells are relatively easy to kill so you can pass the water (and the cells) through the tube at a faster rate and still achieve results. Many other microorganisms (bacteria, virus strains, etc.) are harder to kill so the water needs to pass through the tube slower to achieve a complete kill. The slower the water passes through, the smaller the pond size it can effectively control. Manufacturers who try to control algae call their units “clarifiers” and publish higher flow rates while those who sterilize the water of all living organisms use slower flow rates. A UV clarifier can be used as a sterilizer by simply slowing down the flow of water passing through it.

Always shut off a UV for 24 hours when adding bacteria to a pond. A UV does not discriminate what it is killing so any beneficial bacteria added to the pond would likely pass through the UV and be killed off. Bacteria typically adheres itself to something (filter material) within 24 hours and is then safe.



Commercial UV Clarifiers

Keep water crystal clear with commercial grade clarifiers



- Dual inlets and outlets allow for multiple plumbing options
- Sight indicator shows when unit is on at a glance
- UV-C grade bulbs have 9000 hour life rating
- Polished stainless interior reflector increases light reflection up to 35%
- 2" PVC inlet/outlets — includes union connections
- 15' power cord
- Five year warranty on housing

Part #	Description	Maximum Flow	Maximum Pond Size (gal.)	Qty / Size Bulb	Stocking Code	Ship Weight	List Price
EPUV35	35w Clarifier	1600 GPH	4800	1 / 35w	2335131	10 lbs.	\$515.59
EPUV55	55w Clarifier	2600 GPH	7500	1 / 55w	5367509	12 lbs.	\$565.39
EPUV75	75w Clarifier	3600 GPH	10000	1 / 75w	8540794	15 lbs.	\$831.99
EPUV110	110w Clarifier	4800 GPH	14000	2 / 55w	3712000	23 lbs.	\$1095.39
EPUV150	150w Clarifier	6500 GPH	19000	2 / 75w	61007237	29 lbs.	\$1549.59
EPUV225	225w Clarifier	9000 GPH	24000	3 / 75w	11419599	43 lbs.	\$2183.99

EASYPRO COMMERCIAL UV REPLACEMENT PARTS:

TRANSFORMERS:

Part #	Size	Stocking Code	Ship Weight	List Price
EPUVT35	35w	289995	3 lbs.	\$119.99
EPUVT55	55w	3100791	4 lbs.	\$134.39
EPUVT75	75w	6110394	4 lbs.	\$147.19

BULBS:

Part #	Size	Stocking Code	Ship Weight	List Price
EPUVB35	35w	152499	2 lbs.	\$69.99
EPUVB55	55w	859993	2 lbs.	\$79.99
EPUVB75	75w	583996	2 lbs.	\$111.99

SLEEVES:

Part #	Size	Stocking Code	Ship Weight	List Price
EPUVS35	35w	747691	2 lbs.	\$63.59
EPUVS55	55w	254742	2 lbs.	\$72.99
EPUVS75	75w	366290	2 lbs.	\$88.39

UV Clarifiers & Sterilizers



ULTIMA II BIO-TUBE FILTERS

Ultima II Filters are superior to bead filters because of their patented Bio-Tube media which does not clump together like beads do. No need for a blower for back washing!

- Super easy to backwash — never get your hands wet!
- Unique filter media allows for high flow rates with minimal back pressure
- Bury in ground (up to control head) for easy hiding when used as a pond filter



Patented Bio-Tube Filter media has an extremely high surface area (one cubic foot of media has 750 square feet of surface area) for maximum filtration. This lightweight, non-clogging media is seeded with natural bacteria for quick filter start up after installation.

Performance Data:

Part #	† Max. Pond Size (Gallons)	Max. Lbs. of Fish	Max. GPM Flow	Inlet Outlet Size	Filter Size Ht. x Dia.	Stocking Code	Ship Weight (lbs.)	List Price
AA10	1000	87	17	1½"	22" x 12"	4408651	30	\$681.09
AA20	2000	175	34	1½"	35" x 17"	2555114	39	\$925.19
AA40	4000	350	68	1½"	35" x 21"	8847912	30 + 15 + 15	\$1413.19
AA60	6000	525	80	2"	41" x 23"	31140719	70 + 42 + 40	\$1901.19
AA100	10,000	700	100	2"	42" x 25"	41433511	110	\$2389.19
AA200	20,000	1225	125	2"	48" x 31"	71726313	190	\$2877.19

†Maximum pond size is for water garden applications which typically have a light fish load. Use maximum pounds of fish column for aquaculture and fish holding systems where density of fish is much higher.



STERILIZER/CLARIFIER

- Lifetime warranty on housing
- Designed for outdoor use
- 16' power cord
- All units have 2" inlet/outlet connections for unrestricted flow



Part #	Watts	- As Sterilizer -		- As Clarifier -		Stocking Code	Ship Weight	List Price
		Max. Pond Size Gal.	GPM Flow	Max. Pond size Gal.	GPM Flow			
AU8	8	300	11	1500	16	4151493	7 lbs.	\$252.49
AU15	15	600	12	2000	30	6165539	8 lbs.	\$275.89
AU25	25	1200	20	4000	35	8221512	8 lbs.	\$369.19
AU40	40	2000	47	6000	50	5314456	10 lbs.	\$524.09
AU57	57	3000	54	6500	58	9345051	8 lbs.	\$575.09

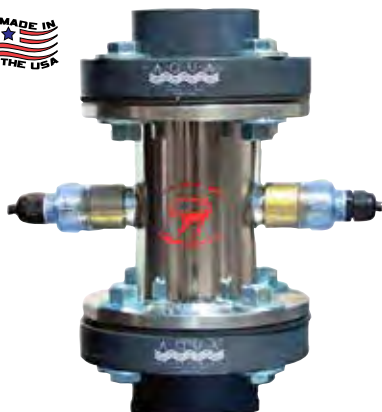

INDUSTRIAL UV

- 3" inlet/outlet
- Includes flow switch to shut off bulb in low flow situations
- Stainless steel body
- 240 GPM maximum flow
- Service kit includes bulb, seals and sleeve

Part #	Description	Stocking Code	Ship Weight	List Price
VIP43	115v Industrial UV	22146074	38, 14, 30 lb.	\$3576.79
VIP432	230v Industrial UV	82075277	38, 14, 38 lb.	\$3458.79
VIP43SK	Service Kit	3317039	5 lb.	\$528.39



UV PARTS:

Part #	Description	Stocking Code	Ship Weight	List Price
AUB8	8 watt Bulb	436952	1 lb.	\$61.59
AUB15	15 watt Bulb	938216	2 lbs.	\$63.69
AUB25	25 watt Bulb	139473	2 lbs.	\$65.79
AUB40	40 watt Bulb	745831	2 lbs.	\$76.39
AUB57	57 watt Bulb	849679	2 lbs.	\$82.79
AUS8	8 watt Sleeve	635691	1 lb.	\$59.49
AUS15	15 watt Sleeve	235697	2 lbs.	\$59.49
AUS25	25 watt Sleeve	238218	2 lbs.	\$63.69
AUS40	40 watt Sleeve	744573	3 lbs.	\$74.29
AUS57	57 watt Sleeve	738211	2 lbs.	\$63.69
AUT8	8 watt Transformer	154777	3 lbs.	\$91.29
AUT15	15 watt Transformer	957291	3 lbs.	\$95.49
AUT25	25 watt Transformer	259873	3 lbs.	\$99.79
AUT40	40 watt Transformer	785318	4 lbs.	\$142.19
AUT57	57 watt Transformer	487894	7 lbs.	\$146.49

EasyPro offers one of the largest selections of pumps in the country! In addition to the many pages of pumps shown, we have hundreds of additional pumps available. We specialize in high volume pumps and can supply you with virtually any size pump you could ever need. Contact us for all your pumping needs. We are glad to help you size and select the proper pump for your application.

Proper Water Pump Selection Is Important!

Selecting a pump can be confusing but it is critical that the proper pump is chosen to ensure longevity and trouble free performance. Following are several things to keep in mind when selecting a pump:

How much volume do you need?

It takes approximately 36 gallons per minute to make a waterfall 1" wide x 1" deep (1" deep water is considered an average depth for residential applications). The first step in determining how much water you need is to multiply the width of the waterfall in feet x 36 = gallons per minute needed to make 1" thick water over your falls.



Example:

A 3' wide waterfall would need 108 gallons per minute to be 1" thick.

This determines how much volume you need

Next, determine how much head (lift) there is from the surface of the pond to the top of the waterfall. On a small, simple waterfall the vertical lift is all you need, however on large applications you also need to factor in friction loss from the pipe as well as each fitting to get the total head.

This determines head pressure

Now that we know water volume needed and the head height it is needed at, it makes selecting a pump much easier. Start by looking at our chart on page 94, this chart lists all of our popular submersible pumps on one page. Look in the yellow box on the right side of the chart - find the column of head closest to your application then follow that column down until you find a pump that delivers the gallons per minute (GPM) you need.

If you have a unique application, are using an external pump or just want our help please do not hesitate to call. Improper pump application is the leading cause of pump failure - we want to help you select the best pump for your application. When calling we need to know the GPM needed, voltage and phase of power available, the length of the pipe run and the diameter of the pipe (if already installed).

Knowing the application and selecting the correct pump for the job will increase the overall performance of the feature and decrease the frustration of frequent call backs and unhappy customers.

Proper plumbing and adequate electrical supply are also critical, please visit our web site for more information.



See our website for more information on selecting pumps



Important Pump Info – Please read and understand this!!

The life of any pump is directly related to the operating conditions it works under. One of the most common causes of premature pump failure is **LOW** head. Pumps are designed to work under a certain amount of load. In low head applications not enough back pressure is put on the pump and it spins too freely. This causes the motors to run hot and shortens their life considerably.



In every plumbing system you should incorporate a valve somewhere in the discharge line. This valve can then be closed part way to simulate back pressure if not enough natural pressure is created.

Testing for Back Pressure - How do you know if your pump has enough back pressure? The best way to test this is through the electrical draw of the motor. Every pump has a label on it which shows the amp draw of the motor. If you have too little back pressure then the amp draw will be high. As you close the valve on the discharge line and increase pressure the amp draw will go down.

By using a simple device like the P3M meter for 115 volt applications you can easily “dial-in” the amp draw of the motor. When you are done, a pumps electric draw should be equal to or less than the amp draw listed on the pump label. You are then within the safe operating range of the motor. For 230 volt motors you can have your electrician test the running amp draw for you or purchase a 230 volt amp meter from a local electrical supply store.

This is the single most important thing you can do to ensure long life, particularly on larger motors!

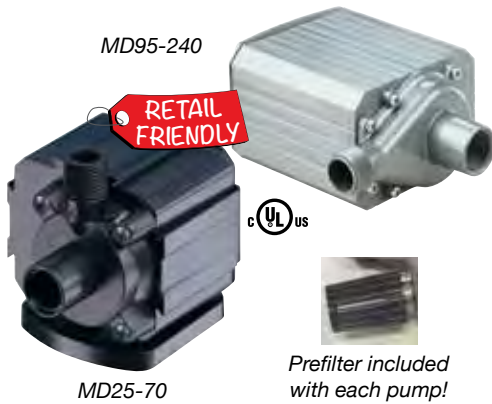

PONDMASTER by Danner

250-700 GPH MAG DRIVE PUMPS

These small pumps are built for use in or out of the water!
Ideal for fountains, spitters and pond use.

- Ceramic shaft
- Foam prefilter included
- Five year warranty

950-1800 GPH MAG DRIVE PUMPS

- Epoxy filled motors (no oil)
- Use in-line or submerged!
- Corrosion proof fasteners
- Tough ABS plastic pump housing
- Heavy duty copper windings
- Five year warranty

Prefilter included with each pump!

Part #	Watts	Max. Flow GPH	GPH Flow @ Ft. of Head					Max. Head	Inlet/Outlet	Power Cord	Stocking Code	Ship Weight	List Price
			3'	6'	9'	12'	15'						
MD25	24	250	175	5	-	-	-	7'	1/2"	10'	868185	4 lbs.	\$104.89
MD35	35	350	300	175	50	-	-	10 1/2'	1/2"	10'	372991	4 lbs.	\$112.29
MD50	45	500	365	180	25	-	-	10 1/2'	1/2"	10'	182153	5 lbs.	\$126.39
MD70	60	700	500	400	270	20	-	13'	1/2"	10'	491978	5 lbs.	\$141.49
MD95	93	950	740	650	505	90	-	13'	3/4"	18'	8114331	7 lbs.	\$175.89
MD120	110	1200	880	755	620	150	-	13'	3/4"	18'	2160547	10 lbs.	\$246.99
MD180	150	1800	1200	1075	925	750	575	17'	3/4"	18'	6182646	10 lbs.	\$280.99
MD240	265	2400	1710	1446	1182	940	720	18'	1"	18'	9227434	12 lbs.	\$349.89

HY-DRIVE PUMPS

Pondmaster Hy-Drive Pumps combine the benefits of magnetic and direct-drive pumps into one hybrid pump! The result is a line of extremely quiet, energy efficient, low maintenance pumps.

- Can be used submerged or out of water as an inline pump
- Can be positioned horizontally or vertically
- 20' power cords
- Includes extra large intake screen
- Back flow check valve included with pump
- Very quiet operation
- No oil — very fish safe!
- 1 1/2" inlet/outlet
- Two year warranty



Part #	Watts	GPM @ Ft. of Head								Inlet/Outlet	Power Cord	Warranty	Stocking Code	Ship Weight	List Price
		0'	2'	4'	6'	8'	10'	12'	14'						
PHD32	200	50	45	39	30	26	23	-	-	1 1/2"	20'	2 Year	1249013	17 lbs.	\$383.09
PHD40	230	65	50	50	41	36	25	5	-	1 1/2"	20'	2 Year	6278657	23 lbs.	\$428.69
PHD48	250	80	79	65	58	48	39	29	18	1 1/2"	20'	2 Year	4315708	27 lbs.	\$485.69
PHD60	675	95	88	81	74	67	60	52	23	1 1/2"	20'	2 Year	5371272	35 lbs.	\$571.19

REPLACEMENT PARTS FOR PONDMASTER MAG-DRIVE PUMPS (Above):

REPLACEMENT FOAM FILTERS:

Part #	Fits Pump Model	Stocking Code	List Price
PRF1	60-190 GPH Pumps (3 pack)	65268	\$8.09
PRF2	250-700 GPH Pumps	210074	\$15.49
PRF3	950-1800 GPH Pumps	711952	\$18.39

Pumps larger than 1800 GPH have inlet strainer but no foam filter

REPLACEMENT IMPELLER COVERS:

Part #	Fits Pump Model	Stocking Code	List Price
PRIC8014	DP80 & DP140	28126	\$12.49
PRIC19	DP190	78123	\$12.49
PRIC2535	MD25 & MD35	38127	\$12.49
PRIC5070	MD50 & MD70	88121	\$12.49
PRIC95	MD95	210338	\$15.89
PRIC1218	MD120 & MD180	610333	\$15.89
PRIC2436	MD240 & MD360	411565	\$17.79
PRIC500	MD500	211890	\$18.29

REPLACEMENT IMPELLERS:

Part #	Fits Pump Model	Stocking Code	List Price
PRI65	DP65	611691	\$17.99
PRI80	DP80	39618	\$14.79
PRI140	DP140	212153	\$18.69
PRI190	DP190	713772	\$21.19
PRI250	MD25	614364	\$22.09
PRI350	MD35 & MD50	917611	\$27.09
PRI700	MD70	317740	\$27.29
PRI950	MD95	125674	\$39.49
PRI1200	MD120	626642	\$40.99
PRI1800	MD180	443096	\$66.29
PRI2400	MD240	553423	\$82.19
PRI3600	MD360	969222	\$106.49

AQUASIS™ Statuary Pumps

SAVE 5% ON A CASE!

- Oil free, fish safe design
- Adjustable flow control
- UL listed
- Clamshell packaged for retail sales
- Twelve per case
- **Two new sizes!**



Part #	Max GPH	Watts	Max Head	Warranty	Outlet Barbs	Power Cord	Stocking Code	Ship Weight	List Price
AP80	80	5	29"	1 year	3/8" - 1/2"	10'	213928	2 lbs.	\$19.89
AP110	110	7	38"	1 year	3/8" - 1/2"	10'	615533	2 lbs.	\$22.19
AP180	180	11	53"	1 year	3/8" - 1/2"	10'	418334	2 lbs.	\$26.19
AP250	250	19	67"	1 year	1/2" - 3/4"	15'	927780	3 lbs.	\$39.69
AP400	400	35	106"	1 year	3/4" - 1"	15'	741641	4 lbs.	\$59.49
AP600	600	39	120"	2 years	3/4" - 1"	15'	875386	5 lbs.	\$107.69
AP1000	1000	80	181"	2 years	3/4" - 1"	15'	386794	5 lbs.	\$123.99
AP1500 NEW	1500	120	210"	2 years	3/4" - 1"	15'	5125575	8 lbs.	\$179.39
AP2500 NEW	2500	215	240"	2 years	3/4" - 1"	15'	5131665	10 lbs.	\$188.09



Oil-Less Solids Handling Pumps

- These pumps are designed for dirty water applications with a clog resistant intake and impeller designed for passing debris laden water
- Solids handling design passes debris up to 3/4" diameter
- Low cost, high quality pumps designed for continuous duty operation
- 1 1/4" side discharge, with a 1 1/4" x 1 1/2" elbow included
- Great 115v pumps for small ponds, statuary, Just-A-Falls, etc.



Part #	HP	GPH	Max Amps	GPM @ Feet of Head						Power Cord	Warranty	Stocking Code	Ship Weight	List Price
				0'	5'	10'	15'	20'	25'					
TS150	1/4	1800	2.8 - 3.2	30	25	16	5	-	-	20'	1 Year	4129996	15 lbs.	\$199.99
TS250	1/3	3000	4.2 - 4.6	50	43	35	27	19	10	20'	1 Year	7155993	15 lbs.	\$239.99
TS400	1/2	3400	5.0 - 5.5	57	50	44	36	27	19	20'	1 Year	5194994	17 lbs.	\$299.99



Fountain Nozzles

These plastic fountain nozzles are ideal for use with mag drive pumps



DIVERTER VALVE SET

Includes diverter valve with 3/4" MPT inlet, 1/2" and 3/4" barbed adapters for tubing connection and a 5 1/2" extension pipe for use with nozzle of choice. EPD10



FOAM JET
Swivel base, 5 3/4" tall
EFN1



DOUBLE VOLCANO
7 1/2" tall
EFN4



VOLCANO
1 3/4" tall
EFN3



WATER BELL
6 1/2" tall
EFN2

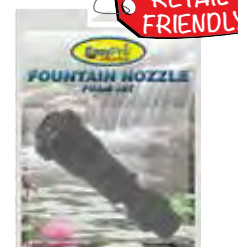

Part #	Description	Stocking Code	Ship Weight	List Price
EFN1	Foam Jet nozzle	88392	1 lb.	\$11.99
EFN2	Water Bell nozzle	48397	1 lb.	\$11.99
EFN3	Volcano nozzle	66990	1 lb.	\$9.99
EFN4	Double Volcano nozzle	18395	1 lb.	\$11.99
EPD10	Diverter Valve set	310493	1 lb.	\$14.99
EP3N	Three Nozzle set	220999	2 lbs.	\$29.99



COMPLETE SET

Includes diverter valve and extension tube with foam jet, volcano and double volcano nozzles in one set. EP3N



Submersible Mag Drive Pumps

EasyPro Mag Drive pumps stand out from the crowd in features, benefits and durability. With fifteen models ranging from 45 gph to the industries largest, 9700 gph, EasyPro offers a model for just about any need. For low head applications Mag Drive pumps are unbeatable and with few moving parts, their reliability is unsurpassed.



- Mag drive motors — quiet and very energy efficient!
- Epoxy filled motors — no oil!
- Foam prefilter included on all pumps 120 gph through 1350 gph. Larger pumps have screened inlet but no foam.
- Flow restricter valve included with each fountain set, 600 gph - 1350 gph fountain sets include diverter valve allowing you to run a fountain nozzle and a waterfall at one time
- We offer a three year limited warranty! EasyPro Mag Drive pumps are built durable, over 98% of these are still running after three years!
- Free fountain set with all 120 - 1350 gph pumps
- Threaded discharge ports on all pumps for easy fitting connection

Three Year Warranty!

SAVE 5% ON A CASE!

Part #	Watts	Max. Flow GPH	GPH Flow @ Ft. of Head						Max. Lift	Power Cord Length	Fountain Nozzles Included	Threaded Outlet Size	Stocking Code	Case Qty.	List Price
			3'	6'	9'	12'	15'	18'							
EP120	9	120	80	-	-	-	-	-	4'	12'	Volcano, Waterbell	3/8"	632363	12	\$49.79
EP200	17	200	160	48	-	-	-	-	7'	12'	Volcano, Waterbell	1/2"	234389	12	\$52.89
EP400	20	400	292	204	61	-	-	-	10'	12'	Volcano, Waterbell	1/2"	159404	12	\$91.39
EP600	35	600	452	310	93	-	-	-	12'	16'	Volcano, Waterbell Double Volcano	1/2"	776435	6	\$117.59
EP850	60	850	637	439	131	-	-	-	12'	16'	Volcano, Waterbell Double Volcano	3/4"	987162	6	\$134.09
EP1050	70	1050	892	740	518	232	-	-	13 1/2'	16'	Volcano, Waterbell Double Volcano	3/4"	4106463	6	\$163.79
EP1350	90	1350	1215	1032	722	467	-	-	15'	20'	Volcano, Dbl. Volcano Waterbell, Foaming Jet	3/4"	5138901	4	\$213.69
EP1750	130	1750	1530	1150	915	782	463	88	20'	20'	None	3/4"	8168344	4	\$258.99
EP2200	190	2200	1848	1478	1108	819	573	137	20'	26'	None	1"	6186747	4	\$287.29
EP3200	260	3200	2720	2284	1598	878	474	103	20'	26'	None	1"	2206379	4	\$317.49

Mag Drive Pump Replacement Parts

REPLACEMENT FOAM FILTERS for EasyPro Mag Drive Pumps

Part #	Stocking Code	Fits Pump	List Price	Part #	Stocking Code	Fits Pump	List Price
EP120F	15267	EP120	\$8.09	EP600F	55452	EP600	\$8.39
EP200F	75459	EP200	\$8.39	EP850F	16103	EP850	\$9.39
EP400F	25456	EP400	\$8.39	EP1050F	46102	EP1050	\$9.39
				EP1350F	36101	EP1350	\$9.39

REPLACEMENT IMPELLERS for EasyPro Mag Drive Pumps

Part #	Stocking Code	Fits Pump	List Price	Part #	Stocking Code	Fits Pump	List Price
EP120I	85971	EP120	\$9.19	EP1050I	117805	EP1050	\$27.39
EP200I	26307	EP200	\$9.69	EP1350I	824172	EP1350	\$37.19
EP400I	611762	EP400	\$18.09	EP1750I	324301	EP1750	\$37.39
EP600I	512284	EP600	\$18.89	EP2200I	228723	EP2200	\$44.19
EP850I	314625	EP850	\$22.49	EP3200I	639385	EP3200	\$60.59



Tabletop Fountain Pumps

- 45 & 65 GPH flow
- Built-in flow control
- One year warranty
- Ideal for tabletop fountains
- 3' maximum lift

SAVE 5% ON A CASE!



Part #	Description	Power Cord Length	Case Quantity	Stocking Code	Ship Weight	List Price
EP45	45 GPH Pump	6'	12	217151	1 lb.	\$26.39
EP65	65 GPH Pump	11'	12	417548	1 lb.	\$26.99



Large Mag Drive Pumps

High volume in a compact, energy efficient design!

- Asynchronous, mag drive pumps
- Super quiet and energy efficient
- EP4700 and EP6700 have 20' power cord, 1 1/2" inlet/outlet and two year warranty; EP9700 has 30' power cord, 2" inlet/outlet and one year warranty
- No oil — fish safe!
- Can be run vertically or horizontally
- Removable prefilter screen
- 115v motors

RETAIL FRIENDLY



SAVE 5% ON A CASE!

Part #	Watts	GPM @ Ft. of Head							Max Head	Warranty	Case Quantity	Stocking Code	Ship Weight	List Price
		0'	4'	8'	12'	16'	20'	24'						
EP4700	470	85	71	55	45	29	19	9	28'	2 Years	2	3252451	18 lbs.	\$388.39
EP6700	520	105	76	63	49	35	23	14	28'	2 Years	2	7339555	19 lbs.	\$522.39
EP9700	750	160	121	98	86	79	63	49	35'	1 Year	2	5438812	20 lbs.	\$675.09

Actual power consumption will vary depending on operating pressures.



Submersible Trash Pumps

This submersible trash pump handles sand, solids, leaves, algae and other debris up to 3/8" x 1" in size.

- 115v motors with 20' power cord and 2" FPT discharge
- Two year warranty!

Cleanout Package

- Includes 25' or 50' of roll-up hose and quick connect fittings to easily connect hose to pump

Great Pond Cleanout Pumps!



ETP05N



Part #	HP	Amps	GPM @ Feet of Head						Stocking Code	Ship Weight	List Price
			5'	10'	15'	20'	25'	30'			
ETP05N	1/2	6.6	57	53	46	39	32	23	6317094	27 lbs.	\$452.99
ETP10N	1	11.5	95	87	78	72	63	57	3380097	34 lbs.	\$542.99
PCH25	25' roll-up hose for pond cleanouts								751990	7 lbs.	\$79.99
PCH50	50' roll-up hose for pond cleanouts								182419	12 lbs.	\$126.79





Stainless Steel TH Pumps

Our Best Selling Pumps!

Energy Efficient, Long Lasting

Great pumps for waterfalls and streams

The "TH Series" of pumps have proven to be a great choice for ponds, waterfalls, fountains and similar applications. Thousands of these pumps are in use throughout North America in a wide variety of continuous duty applications. Compact design is ideal for use in skimmers. One of the industry's best selling pumps.

- Rugged motor — designed for long life, continuous duty operation; motor housing is corrosion-resistant stainless steel
- Low maintenance — pump casing is made from abrasion-resistant, fiber reinforced plastic for maximum life
- Vortex design prevents clogging
- Built-in overload and overheat motor protection
- 2" female threaded outlet



HTA Companies, Inc. (MI)

Over 48,000 TH Pumps Sold!

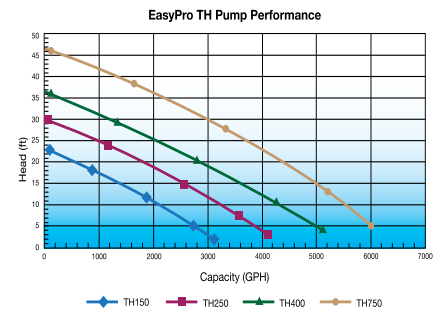

Part #	GPH	HP	Amps/Volts	GPM @ ft. of head						Max. Head	Power Cord	Warranty	Stocking Code	Ship Weight	List Price
				0'	5'	10'	15'	20'	25'						
TH150	3100	1/4	2.6-3.1/115	52	46	35	23	10	-	23'	20'	2 Years	1251873	19 lbs.	\$387.49
TH1502	3100	1/4	1.3-1.5/230	52	46	35	23	10	-	23'	20'	2 Years	5255962	19 lbs.	\$393.79
TH250	4100	1/3	3.0-4.2/115	68	65	54	43	30	15	30'	20'	2 Years	6314461	22 lbs.	\$483.79
TH2502	4100	1/3	1.5-2.1/230	68	65	54	43	30	15	30'	20'	2 Years	7319734	22 lbs.	\$491.89
TH400	5100	1/2	3.7-6.0/115	85	83	73	60	46	34	36'	20'	2 Years	4370496	25 lbs.	\$569.99
TH4002	5100	1/2	1.8-3.0/230	85	83	73	60	46	34	36'	20'	2 Years	9375378	25 lbs.	\$577.49
TH750	6000	1	6.0-9.9/115	100	98	91	83	73	62	46'	20'	2 Years	5453505	28 lbs.	\$697.69
TH7502	6000	1	3.0-4.9/230	100	98	91	83	73	62	46'	20'	2 Years	7460972	28 lbs.	\$709.19
THPS	Bottom screen for all sizes of TH pumps (fits mid 2009 models & newer)											312990	1 lb.	\$19.99	

Attractively packaged for retail sales • Dealer inquiries welcome on large orders

115 volt TH Pumps with 50' or 100' Cords

TH PUMPS WITH 50' CORD

Part #	Stocking Code	Ship Weight	List Price
TH150-50	1282095	22 lbs.	\$433.99
TH250-50	8345142	25 lbs.	\$530.99
TH400-50	3401631	28 lbs.	\$617.89
TH750-50	2489183	31 lbs.	\$752.59

TH PUMPS WITH 100' CORD

Part #	Stocking Code	Ship Weight	List Price
TH150-100	5332474	28 lbs.	\$511.49
TH250-100	3396361	31 lbs.	\$609.79
TH400-100	9453502	34 lbs.	\$697.69
TH750-100	4548660	39 lbs.	\$844.09



TM Low Head Series

Perfect for streams and waterfalls

- Up to 17,500 GPH flow
- 3" outlets with 30' power cords and thermal overload protection
- Oil free design — ideal for fish ponds
- Top quality Japanese double mechanical seals for maximum life
- Two year warranty
- Ideal for low to medium head waterfalls
- High volume in a compact design allows for use in large skimmers



Part #	HP	Max Amps	Voltage	Max GPH	Max GPM	Power Cord	Outlet Size	Stocking Code	Ship Weight	List Price
TM9500	1	10.9	115	9500	158	30'	3"	4602908	54 lbs.	\$893.19
TM13500	1.5	12	115	13500	225	30'	3"	7795413	63 lbs.	\$1178.39
TM17500	2	10	230	17500	290	30'	3"	1985499	74 lbs.	\$1459.99

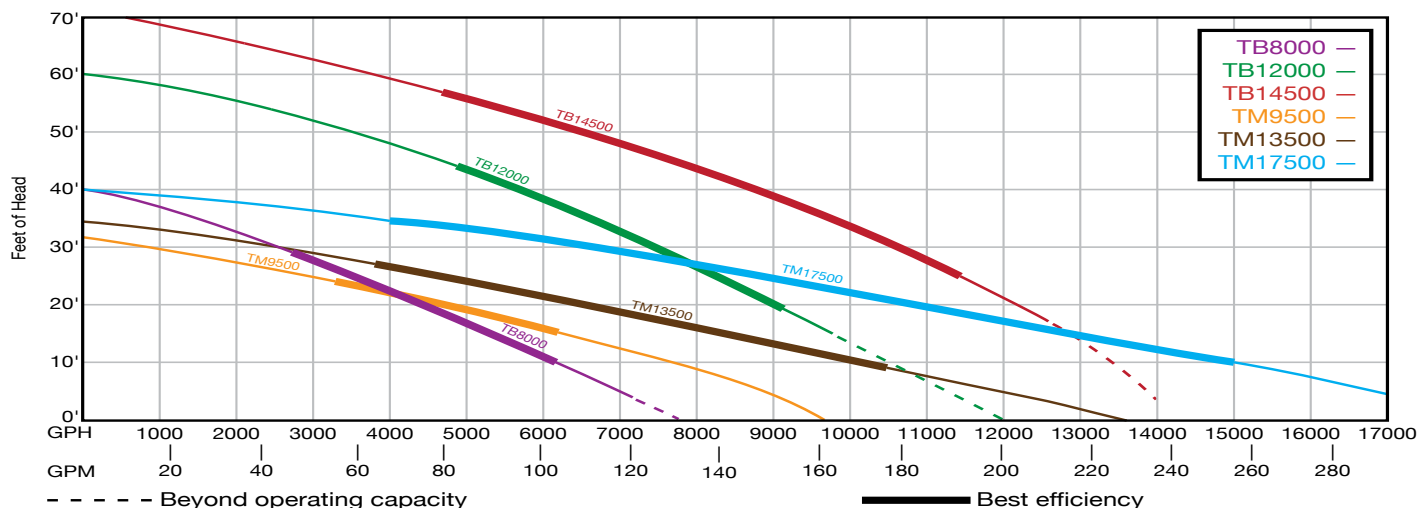

TB High Head Series

The best choice for water features above 20'

- 3" outlets with 20' power cords and thermal overload protection
- Top quality Japanese double mechanical seals — over 100,000 hour life expectancy
- 230 volt (1 HP available in 230v or 115v)
- Two year warranty
- Designed for use with higher head pressure
- Applications: A **minimum** of 20' head pressure required for TB12000 and TB14500, use ball valve to create back pressure if system has less than 20' head pressure



Part #	HP	Max Amps	Voltage	Max GPH	Max GPM	Power Cord	Outlet Size	Stocking Code	Ship Weight	List Price
TB8000	1	11	115	8000	133	20'	3"	1507492	43 lbs.	\$724.99
TB8002	1	5.5	230	8000	133	20'	3"	6507495	43 lbs.	\$724.99
TB12000	2	9.7	230	12000	200	20'	3"	9845870	68 lbs.	\$1208.39
TB14500	3	14.5	230	14500	240	20'	3"	8924831	74 lbs.	\$1321.19



Matala[®] Horizontal Skimmer Pumps

Horizontal design allows use in shallow water applications without overheating!

Two Year Warranty



- Operates in horizontal or vertical position!
- Vortex style intake reduces plugging
- Removable inlet screen prevents large objects from plugging pump
- Continuous duty rated motors
- Energy efficient design reduces operating costs
- 115v motor with 2" outlets and 20' power cord



Part #	HP	Max GPH	Max Amps	GPM @ ft. of head						Max. Head	Stocking Code	Ship Weight	List Price
				0'	5'	10'	15'	20'	25'				
MHP32	1/5	3200	2.8	54	48	34	14	-	-	19'	5245744	20 lbs.	\$393.19
MHP39	1/3	3900	3.2	64	60	46	24	2	-	23'	4258681	20 lbs.	\$413.89
MHP47	1/2	4700	5.3	78	71	59	45	30	11	30'	7344932	27 lbs.	\$551.89
MHP56	1	5600	7.3	93	91	90	84	68	51	29'	6495813	30 lbs.	\$793.29



TSURUMI PUMP

18 Month Warranty

- Top discharge design provides maximum motor cooling for longer life
- Compact design makes these pumps ideal for tight spots
- Continuous duty motors with 60,000 hour bearings — that's almost seven years of continuous operation!
- Built in over load protection
- 2" male threaded outlets and 30' power cord

Part #	HP	Amp/Volts	GPM @ Feet of Head					Stocking Code	Ship Weight	List Price
			1'	10'	20'	30'	40'			
TLB400	2/3	5.4/115	63	58	43	23	-	7422694	30 lbs.	\$650.29
TLB750	1	11/115	73	72	66	55	40	2647009	48 lbs.	\$995.39
TLB7502	1	6/230	73	72	66	55	40	5647003	48 lbs.	\$995.39



F&Q

Submersible Pumps

One Year Warranty

These two pumps are a smaller version of the high volume pumps found on the next page. Although these pumps are smaller they still have impressive flow rates and their smaller size makes them perfect for use with our large pond skimmer (page 6).

- 3450 rpm motors with built in thermal protection and automatic reset, single phase in 115 volt only

Part #	HP	Volts	Amps	GPM @ feet of head						Max Head	Discharge	Power Cord	Stocking Code	Ship Weight	List Price
				5'	10'	15'	20'	25'	30'						
FQ05	1/2	115	10	88	76	60	35	-	-	23'	2"	20'	2291871	55 lbs.	\$466.99
FQ10	1	115	15	125	110	80	57	25	-	33'	2"	20'	7363626	58 lbs.	\$581.79

High Volume Submersible Pumps

These heavy duty, cast iron pumps are perfect for waterfalls

While these pumps are not as long lasting as Goulds and EasyPro Pumps, the high flow and low cost make them a popular choice for large waterfalls. They are the largest 115v submersible pumps we offer.

- All pumps available in 115v or 230v with one year warranty
- 30' power cords



Part #	HP	Volts	Amps	GPM @ feet of head						Max Head	Discharge	Stocking Code	Ship Weight	List Price
				5'	10'	15'	20'	25'	30'					
WQ50	1/2	115	8	160	130	65	-	-	-	18'	3"	3412314	95 lbs.	\$659.69
WQ502	1/2	230	4	160	130	65	-	-	-	18'	3"	6424066	95 lbs.	\$678.49
WQ75	3/4	115	11	178	152	120	60	-	-	23'	3"	7451681	100 lbs.	\$722.69
WQ752	3/4	230	5.5	178	152	120	60	-	-	23'	3"	2464562	100 lbs.	\$743.29
WQ100	1	115	13	195	176	150	66	17	-	26'	3"	8495687	105 lbs.	\$793.09
WQ1002	1	230	6.5	195	176	150	66	17	-	26'	3"	1509874	105 lbs.	\$815.79
WQ150	1.5	115	16	285	245	180	132	65	40	32'	3"	4553629	115 lbs.	\$885.79
WQ1502	1.5	230	8	285	245	180	132	65	40	32'	3"	9569431	115 lbs.	\$911.09

Low Head, High Volume Submersible Pumps

- German engineered commercial grade pumps
- Dual silicon carbide seals for maximum life
- Oil free, air cooled motors
- Vortex impeller design allows for maximum solids handling without plugging
- 25' power cord with quick disconnect
- 4" flanged outlet — use GCP30FK flange kit for new installations

All pumps include a separate remote starter which needs to be installed in an enclosure by an electrician on-site or a deluxe control panel with starter (right) is available.

- Deluxe controls include NEMA4 enclosure, starter, circuit breaker and overload relay



JVSCP



Part #	HP	230v. Amps	GPM Flow Rate @ Ft. of Head								Max. Head	Stocking Code	Ship Weight	List Price
			0'	10'	15'	20'	25'	30'	35'	40'				
JVS15*	1.5	11.6	350	215	150	85	-	-	-	-	23'	22692733	108 lbs.	\$3474.49
JVS20*	2	15.5	400	305	220	155	100	30	-	-	32'	12814336	110 lbs.	\$3631.39
JVS30*	3	18.5	485	370	280	215	165	110	55	-	36'	43190698	117 lbs.	\$4116.99
GCP30FK	Flanged Outlet Kit											578740	8 lbs.	\$104.99
JVSCP	Deluxe Control Panel with Starter Upgrade											3755629	18 lbs.	\$974.99

*Factory direct shipping, motor freight only. Shaded area is preferred operating range

High Volume Submersible Pumps by Goulds

For high volume, continuous water needs, these pumps are a great choice

These pumps are rated for "Heavy Duty" applications and will provide years of reliable use.

- 20' "Severe Duty" power cords standard
- 4" flanged discharge, new installations require the WSF flange kit
- Non clog, cast iron impeller and built-in thermal protection with automatic reset
- 230 volt, 1750 rpm motors – single phase, 230/460 volt, 1750 rpm motors – 3 phase
- Capable of running dry for short periods without damage



Part #	HP	230v. Amps	GPM Flow Rate @ Ft. of Head								Stocking Code	Ship Weight	List Price	
			10'	15'	20'	25'	30'	35'	40'	45'				
WS15*	1.5	13.2	400	320	230	110	-	-	-	-	32635193	195 lbs.	\$3513.59	
WS20*	2	16.3	-	370	300	205	100	-	-	-	62924091	200 lbs.	\$3898.79	
WS30*	3	21.5	-	490	440	360	270	160	75	-	13542478	208 lbs.	\$4723.29	
WS50*	5	26.5	-	-	570	440	360	275	175	85	53790792	213 lbs.	\$5054.39	
WSF	4" Flange with bolts for all WS Pumps											280179	9 lbs.	\$106.89

*Factory direct shipping, motor freight only. Shaded area is preferred operating range



Super High Volume Submersible Pumps

All Stainless Steel Construction

These high volume, low head pumps are truly in a class of their own! All pumps feature Axial-flow lift for smooth, low vibration, low pressure operation. Ideal pumps for large scale recirculation systems, dewatering, high volume water transfer and large waterfalls. All pumps are available in single and three phase and are available with a variety of options including automatic on/off, alarm activation, delayed start and more. Prices are for 230 volt, single phase pumps, please call for pricing on all others.

- 30' power cords standard — longer available
- 1/2, 3/4 and 1 HP pumps do not require a control panel
- 2 HP and larger pumps include a control panel

Unlike regular centrifugal pumps which can be valved back to reduce the flow, Axial-flow pumps need to be able to get rid of all the water they can produce. It is for this reason that it is important to use the correct size plumbing and to never valve back the pump. Please refer to the minimum pipe size column in the chart below for correct plumbing size.



All models are available in both vertical or horizontal styles. See next page for intake screens or horns as accessories.



Landscape Design Services (MI)

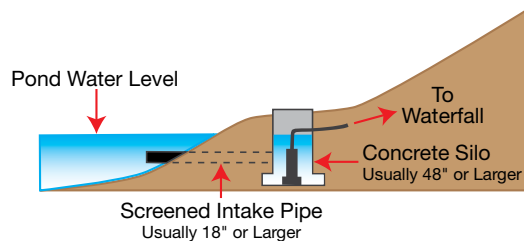

Typical wet well installation — contact us for design assistance!

Part #	GPM at Feet of Head							Max. Head
	2'	4'	8'	12'	16'	20'	24'	
CP50-1	250	200	135	30	—	—	—	12'
CP100-2	380	340	250	—	—	—	—	12'
CP402-1	415	380	345	280	175	—	—	16'
CP403-2	490	475	425	320	125	—	—	16'
CP605-2	950	930	860	770	—	—	—	15'
CP605-1	740	710	655	600	550	490	—	20'
CP607-3	1105	1080	1010	905	820	700	—	20'
CP607-1	750	705	630	525	460	395	300	25'
CP610-4	1300	1270	1225	1150	1050	—	—	17'
CP610-3	1130	1100	1040	960	840	700	550	25'
CP615-4	—	1500	1420	1300	1150	1025	875	25'



2 HP and larger pumps include a control panel.

Call for specifics and pricing.

Several models of Carry pumps have multiple impellers to choose from. Larger impellers produce higher flow rates but have less feet of head limits. The same pump with a smaller impeller provides less water flow but can push it to higher limits.

Carry Axial-flow pumps have no minimum head pressure unlike most submersible pumps. Their unique design makes them ideal for low head applications.

Prices shown at left are for 230v, single phase, horizontal style mount pumps.

When ordering vertical style 230v single phase be sure to add a "V" after part number. For 1/2 to 3 HP vertical add \$125.00; for 5 to 15 HP vertical add \$200.00.

Horizontal pumps are used typically for "in-pond" applications. Vertical styles are used in "water-well" applications.

Part #	HP	230v. Amps	Discharge Diameter	Minimum Outlet Pipe Size	Stocking Code	Ship Weight	List Price
CP50-1	1/2	6	4"	4"	31237991	43 lbs.	\$1547.49
CP100-2	1	9	4"	4"	41383672	49 lbs.	\$1729.59
CP402-1	2	10	4"	6"	62245030	55 lbs.	\$2806.29
CP403-2	3	14	4"	6"	82922234	80 lbs.	\$3652.79
CP605-2	5	23	6"	8"	54205433	155 lbs.	\$5256.79
CP605-1	5	23	6"	8"	44205432	155 lbs.	\$5256.79
CP607-3	7.5	36	6"	8"	95252318	172 lbs.	\$6565.39
CP607-1	7.5	36	6"	8"	85252317	172 lbs.	\$6565.39
CP610-4	10	44	6"	10"	45893836	201 lbs.	\$7367.29
CP610-3	10	44	6"	10"	35893835	201 lbs.	\$7367.29
CP615-4	15	62	6"	10"	26865593	270 lbs.	\$8581.99



Intake Screens & Horns

HORIZONTAL PUMP INTAKE SCREENS

- Heavy duty screens are designed to be used with pumps to prevent sticks, weeds, fish, etc. from plugging pump
- Made from SDR35 PVC and high density polyethylene top and bottom plates, screen portion is perforated with 1/2" holes



Horizontal pump with intake screen

PUMP INTAKE HORNS

- Intake horns are a factory installed option that are used when pumping in shallow applications to direct the suction towards the bottom of the pump and prevent pumps from sucking air
- Highly recommended on larger pumps being used in ponds or pools less than 30" deep



Horizontal pump with intake horn

Part #	Description	Stocking Code	Ship Weight	List Price
CPSA*	Intake Screen for 1/2, 3/4 or 1 HP	3322871	13 lbs.	\$403.59
CPSB*	Intake Screen for 2, 3 HP	7311911	39 lbs.	\$389.89
CPSC*	Intake Screen for 5, 7 1/2, 10 HP	8482157	47 lbs.	\$602.69
CPI4	Intake Horn for 1/2 - 1 HP	667437	6 lbs.	\$84.29
CPI6	Intake Horn for 2 - 15 HP	9143357	9 lbs.	\$179.19

*Horizontal screens, vertical screens available - call for pricing

A variety of on/off floats for automatic operation are also available - please inquire



Fountain Pumps

These single stage turbine pumps operate under much higher head pressure making them ideal for fountains and high head waterfalls.

- Available in 1.5 or 3 HP, 230v single phase or three phase motors
- Stainless steel design for years of continuous operation
- Motor protected from plugging by PVC screen
- 3 HP pumps require control panel (sold separately)



Part #	HP	Amps @ 230v	GPM @ feet of head						Max. Head	Stocking Code	Ship Weight	List Price
			10'	20'	30'	40'	50'	60'				
CFP15*	1.5	11.5	-	130	116	96	73	40	66'	21511911	45 lbs.	\$1889.89
CFP30*	3	17	250	230	208	183	152	125	72'	71863836	65 lbs.	\$2329.79
CFP30P	3 HP Control Panel									4352792	15 lbs.	\$440.99

*Add "V" after part number for vertical pump, same price

Extreme Waterfall Pumps

We offer many choices when it comes to large waterfall pumps.

We have pumps available all the way up to 500 hp!

When sizing a large pump it is critical that you choose the correct style of pump. Please allow us to help you select the correct pump for your application. A little planning now will save A LOT of headache later.



Tsurumi offers many large pumps from 5 hp to 50 hp!



Carry offers pumps up to 50 hp with 9,000 gpm (540,000 gph) flows!



Pump Comparison Chart



Use the information on this page to simplify selecting a pump for a given application.
As described on page 83, selecting a pump involves a couple steps:

- 1) determine the flow needed: multiply width (in feet) x 36 gpm = flow needed in gpm
 - 2) determine the head pressure in feet (the height the water will rise above the surface of the pond it is being pumped from)
- To find a pump go to the white box on the right side of this page. Find the foot of head column that is closest to your application (always round up to next column). Now scroll down that column looking for a pump that provides the gpm you determined you needed in step 1. If multiple pumps fit your application you can compare cost to operate, outlet size, etc. to finalize your selection.

Part#	Pg #	HP	AMPS	@	Volts	Cost for 24 hrs**	Outlet Size	Cord Length	Dimension		Flow Rates (GPM) @ Feet of Head						Max Head
									Dia	Height	5'	10'	15'	20'	25'	30'	
EP3200*	86	-	2.2		115	.56c	1"	30'	12"	7"	41	23	8	-	-	-	16'
EP4700*	87	N/R	2.4		115	.60c	1.5"	20'	9"	8"	67	50	33	19	2	-	28'
EP6700*	87	N/R	4.5		115	\$1.12	1.5"	20'	11"	8"	73	56	38	23	11	-	28'
EP9700*	87	N/R	6.1		115	\$1.51	2"	30'	18"	9"	116	92	83	63	47	22	35'
MHP32	90	1/5	2.8		115	.70c	2"	20'	14"	7"	48	34	14	-	-	-	19'
MHP39	90	1/3	3.2		115	.79c	2"	20'	14"	7"	60	46	24	2	-	-	23'
MHP47	90	1/2	5.3		115	\$1.32	2"	20'	15"	7"	71	59	45	30	11	-	30'
MHP56	90	1	7.3		115	\$1.81	2"	20'	16"	7"	91	90	84	68	51	29	37'
TH150*	88	1/4	2.6-3.1		115	.72c	2"	20'	10"	15"	46	35	23	10	-	-	23'
TH250*	88	1/3	3.0-4.2		115	.99c	2"	20'	10"	15"	65	54	43	30	15	-	30'
TH400*	88	1/2	3.7-6.0		115	\$1.39	2"	20'	10"	17.5"	83	73	60	46	34	20	36'
TH750*	88	1	6.0-9.9		115	\$2.36	2"	20'	10"	17.5"	98	91	83	73	62	49	43'
TM9500*	89	1	10.9		115	\$2.70	3"	30'	12"	19.5"	142	127	108	81	50	16	31'
TM13500*	89	1.5	12		115	\$2.98	3"	30'	12"	21"	191	166	141	106	76	43	34'
TM17500*	89	2	10		230	\$4.96	3"	30'	12"	21"	275	250	215	183	147	108	40'
TB8000*	89	1	11		115	\$2.73	3"	20'	11"	18"	116	101	90	73	58	41	40'
TB8002*	89	1	5.5		230	\$2.73	3"	20'	11"	18"	116	101	90	73	58	41	40'
TB12000*	89	2	9.7		230	\$4.81	3"	20'	12"	21"	-	-	165	150	136	123	60'
TB14500*	89	3	14.5		230	\$7.20	3"	20'	12"	22.5"	-	-	211	203	191	178	72'
ETP05N*	87	1/2	5.6		115	\$1.27	2"	20'	10"	13"	57	53	46	39	32	23	38'
ETP10N*	87	1	12		115	\$2.98	2"	20'	10"	15"	95	87	78	72	63	57	57'
TLB400	90	2/3	5.4		115	\$1.34	2"	30'	8"	12"	61	58	51	43	34	23	39'
TLB750	90	1	11.0	115/230		\$2.73	2"	30'	8"	17"	73	72	69	66	61	55	60'
FQ05	90	1/2	10		115	\$2.48	2"	33'	10"	17"	88	76	60	35	-	-	23'
FQ10	90	1	15		115	\$3.72	2"	33'	10"	17"	125	110	80	57	25	-	33'
WQ50	91	1/2	8	115/230		\$1.98	3"	33'	15"	21"	160	130	65	-	-	-	18'
WQ75	91	3/4	11	115/230		\$2.73	3"	33'	15"	21"	178	152	120	60	-	-	23'
WQ100	91	1	13	115/230		\$3.23	3"	33'	15"	21"	195	176	150	66	17	-	26'
WQ150	91	1-1/2	16	115/230		\$3.97	3"	33'	15"	21"	285	245	180	132	65	40	32'

Part#	Pg #	HP	Phase	230v Amps	Volts													
JVS15	91	1-1/2	1 or 3	11.6	230	\$5.76	4"	25'	16"	19"	282	215	150	85	-	-	-	23'
JVS20	91	2	1 or 3	15.5	230	\$7.70	4"	25'	16"	19"	350	305	220	155	100	30	-	32'
JVS30	91	3	1 or 3	18.5	230	\$9.19	4"	25'	16"	20"	425	370	280	215	165	110	-	36'
WS15	91	1-1/2	1 or 3	13.2	230/460	\$6.56	4"	20'	16"	28"	-	400	320	230	110	-	-	31'
WS20	91	2	1 or 3	16.3	230/460	\$8.10	4"	20'	16"	28"	-	-	370	300	205	100	-	35'
WS30	91	3	1 or 3	21.5	230/460	\$10.68	4"	20'	16"	28"	-	-	490	440	360	270	-	46'
WS50	91	5	1 or 3	26.5	230/460	\$13.17	4"	20'	16"	28"	-	-	-	570	440	360	-	51'

Carry Manufacturing Low Head Pumps										GPM@									
Part#	Pg #	HP	Phase	230v Amps	Volts	Cost	Outlet Size	Cord Length	Dimension	2'	4'	8'	12'	16'	20'	25'	30'	35'	40'
CP50-1	92	1/2	1 or 3	6.0	230	\$2.98	4"	30'	19"	8"	250	200	135	30	-	-	-	-	12'
CP100-2	92	1	1 or 3	9.0	230	\$4.47	4"	30'	20"	9"	380	340	250	-	-	-	-	-	12'
CP402-1	92	2	1 or 3	10	230	\$4.96	4"	30'	19.75"	9.75"	415	380	345	280	175	-	-	-	16'
CP403-2	92	3	1 or 3	14	230	\$6.96	4"	30'	21.5"	9.75"	490	475	425	320	125	-	-	-	16'
CP605-2	92	5	1 or 3	23	230	\$11.42	6"	30'	31"	14"	950	930	860	770	-	-	-	-	15'
CP605-1	92	5	1 or 3	23	230	\$11.42	6"	30'	31"	14"	740	710	655	600	550	490	-	-	20'
CP607-3	92	7-1/2	1 or 3	36	230	\$17.88	6"	30'	38"	15"	1105	1080	1010	905	820	700	-	-	20'
CP607-1	92	7-1/2	1 or 3	36	230	\$17.88	6"	30'	38"	15"	750	705	630	525	460	395	-	-	25'
CP610-4	92	10	1 or 3	44	230	\$21.86	6"	30'	38"	15"	1300	1270	1225	1150	1050	-	-	-	17'
CP610-3	92	10	1 or 3	44	230	\$21.86	6"	30'	38"	15"	1130	1100	1040	960	840	700	-	-	25'
CP615-4	92	15	1 or 3	62	230	\$30.80	6"	30'	42"	16"	-	1500	1420	1300	1150	1025	-	-	25'

*Indicates EasyPro brand pumps **Calculated at .09c per kilowatt hour

Plastic pipe: friction loss (in feet of head) per 100' of pipe

Feet of head is typically measured in terms of vertical lift. However, the diameter and length of pipe can have a significant effect on the performance of the pump as well, especially if the pipe diameter is too small. A pump must have the power to not only push the water up to the vertical height of the waterfall, but to also overcome the friction loss created by the pipe. **Total Dynamic Head** is the feet of head (lift) added to the friction loss created by the pipe. In most small ponds with short pipe runs friction loss is not typically a problem. However, in a feature with long streams or high flow rates, friction loss can have a big impact on the performance of the pump. To determine the Total Dynamic head you would add the feet of head and the friction loss. The chart at the right lists the feet of head equivalent created by flow and pipe diameter. (Figures based on 100' pipe.)

GPM	GPH	1"	1 1/4"	1 1/2"	2"	3"	4"	6"	8"	10"
20	1,200	21.75	5.59	2.61	.76	.11				
30	1,800		11.85	5.53	1.62	.23				
40	2,400		20.18	9.43	2.75	.40	.12			
50	3,000			10.51	4.25	.66	.17			
60	3,600			19.98	5.84	.85	.25			
70	4,200				7.76	1.13	.33			
80	4,800				9.94	1.44	.41			
90	5,400				12.37	1.80	.52			
100	6,000				15.03	2.18	.63	.08		
125	7,500					3.31	.95	.13		
150	9,000					4.63	1.33	.18		
175	10,500					6.16	1.78	.23		
200	12,000					7.88	2.07	.30		
250	15,000					11.93	3.16	.45	.12	
300	18,000						4.45	.63	.17	
350	21,000						5.87	.84	.22	
400	24,000						7.52	1.08	.28	
500	30,000							1.66	.42	.14
600	36,000							2.35	.59	.19
700	42,000							3.65	.79	.26
800	48,000								1.02	.33
900	54,000								1.27	.41
1000	60,000								2.15	.50
1250	75,000								2.20	.73
1500	90,000								3.07	1.01

Example

We are pumping 70 GPM (4200 GPH). The chart shows that 70 GPM through 100' of 2" pipe equals 7.76' of head while a 3" pipe only equals 1.13' of head. If your waterfall is 10' high and 100' away, you will have a total head of 17.76' using 2" pipe but only 11.13' using 3" pipe.

10.00' Vertical Lift	10.00' Vertical Lift
+ 7.76' Friction Loss	+ 1.13' Friction
= 17.76' Total Dynamic Head	= 11.13' Total Dynamic Head

Confused? Give one of our technical advisors a call and we'll walk you through it!

Pipe Comparison

Many people mistakenly think that there really isn't much difference between (for example) 1 1/2" and 2" pipe or between 3" to 4" pipe. The chart to the right shows how many square inches of surface area are on the inside of flexible PVC pipe.

Pipe Size (dia.)	Square Inches of Surface Area
1"	.79
1 1/2"	1.77
2"	3.14
3"	7.07
4"	12.57
6"	28.27
8"	50.26

As you can see, there is a big difference between 1 1/2" and 2" pipe — almost 80% more space! This shows why using the correct size pipe is important to the output of your pump.



Low Water Pump Shut-Offs



"TETHER-STYLE" SHUT OFF SWITCHES

Prevent costly motor damage to submersible pumps from low water with these "tether style" float switches. Ideal for pumps used in skimmers! Easy to install, plug in connection eliminates electrical wiring.

- 15' long power cable, maximum amps - 13

Low water shut off for submersible pumps — prevents costly damage to water cooled motors!



DIAPHRAGM STYLE SHUT OFF SWITCHES

115 or 230 volt Diaphragm switches are ideal for use in tight spaces where the "tether-style" switches would be too big.

- Maximum amp. load - 10 amps
- 115v has plug in style connections and 10' power cord, 230v has pigtail wiring and 8' power cord

Part #	Description	Stocking Code	Ship Weight	List Price
LGS1	115 Volt Switch	959211	2 lbs.	\$84.59
LGS2	230 Volt Switch	559216	2 lbs.	\$84.59

Part #	Description	Stocking Code	Ship Weight	List Price
LGS3	115 Volt Switch	759218	3 lbs.	\$84.59
LGS4	230 Volt Switch	459216	3 lbs.	\$84.59

Centrifugal Pump Intake Filters

Use on pump suction lines to prevent plugging and damage to your pump

Filters come with 2" female threaded check valve and are 36" in length. Use single screen filter in low GPM applications or to prevent fish from entering intake in clean water applications. Use dual screen filters in dirty water applications to prevent plugging. Filters are easily disassembled for cleaning and all parts are replaceable. Screens are made from vinyl encapsulated polyester, all other parts are PVC. Available with copper screening for zebra mussel applications, call for pricing. Flow rate of 40-50 gpm recommended, maximum flow rate 90 gpm.

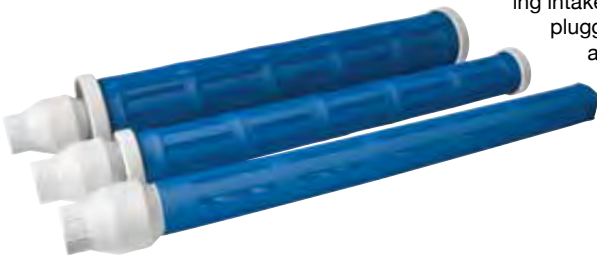

Part #	Description	Stocking Code	Ship Weight	List Price
UF3	3" Dia. Filter, Single Screen	272531	4 lbs.	\$111.59
UF4	4" Dia. Filter, Dual Screen	1110104	8 lbs.	\$169.39
UF6	6" Dia. Filter, Dual Screen	5160153	11 lbs.	\$246.39



High Volume Centrifugal Pump Intake Filters

For high volume pumping applications these heavy duty pump intake screens are the answer!

For most high volume pumps these filters are a much better choice as they will allow fine particles through so screens will not plug up as often yet will still keep out large objects such as sticks, fish and weeds.

- Made from epoxy coated heavy gauge galvanized wire, will not rust or corrode
- Mesh size is 1/2" x 1"
- Includes PVC swing check valve to keep pumps primed



Part #	Pipe Size	Screen Size Length	Screen Size Diameter	Max. Recommended Flow (GPM)	Stocking Code	Ship Weight	List Price
PIF2	2"	18"	11"	90	289696	10 lbs.	\$137.99
PIF3	3"	30"	11"	225	3129992	15 lbs.	\$199.99
PIF4	4"	30"	11"	350	7194995	20 lbs.	\$299.99
PIF6	6"	48"	20"	700	6334297	51* lbs.	\$514.29
PIF8	8"	48"	20"	1000	9492374	72* lbs.	\$757.49



Submersible Pump Screens

Use these handy intake screens with any submersible pump when pumping water from a lake, pond, river or tank. These sturdy built screens will protect pump from sticks, weeds, fish and other large debris.

- Available in two sizes — 12" diameter x 14" tall or 20" diameter x 18" tall
- Heavy duty 1/2" x 1" mesh screen
- Drawstring top allows for easy pump removal/inspection and will draw up tight to any pipe from 1 1/2" to 4" in diameter
- Screens can be used vertically or horizontally

Part #	Description	Stocking Code	Ship Weight	List Price
SPS12	Pump Screen, 12" Dia x 14" Tall	374167	7 lbs.	\$114.09
SPS20	Pump Screen, 20" Dia x 18" Tall	7114393	18 lbs.	\$175.99



Filter Stand

Universal design — holds all types of screens up off the bottom

- Use to reduce the cleaning and maintenance of submersible pumps or intake screens on shore mounted pumps by keeping them up off the bottom
- Great for irrigation systems where plugging is a problem!



Ideal for use with UF3, UF4, UF6, PIF2, PIF3 and PIF4 on this page!

Part #	Description	Stocking Code	Ship Weight	List Price
FILS	Filter Stand	7174433	22 lbs.	\$249.19



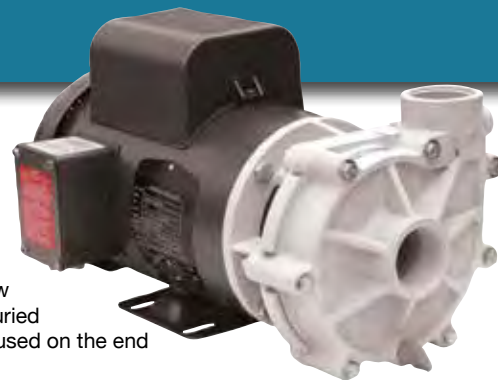

External Pumps

EasyPro offers a variety of external pumps in both non-priming and self-priming styles. External pumps offer several advantages over submersible pumps including reduced energy costs and longer average life span.

Non-priming pumps are best used in flooded suction applications. This means the pump sits below the water level it is pumping. Examples would be alongside of a fish tank or in a pump chamber buried alongside of a pond. These pumps can sit above the water level, however, a check valve must be used on the end of the suction line to keep the pump primed.

Self-priming pumps have the capability of purging some air from the suction line and priming themselves (after filling the pump with water the first time). These pumps can sit above the water level without a check valve in the suction line, however, using a check valve speeds up the priming process and ensures a quick flow when the pump is plugged in.

Following is a comparison chart between our most popular external pumps. Use this chart to help select which pump is best for your application. Start by finding the feet of head column on the right side of the chart. Look down the numbers under the feet of head in your application to find a pump that provides the amount of water needed.

Low Head Pumps

Part #	Pg #	Max Amps	Volts	Cost for 24 hrs	Outlet Pipe Size	Cord Length	Self Priming	Flow Rates @ Feet of Head					Max Head	
								5'	10'	15'	20'	25'		30'
EX3600	98	1.4	115	.34¢	2"	8'	No	52	34	-	-	-	-	12'
EX4500	98	2.7	115	.67¢	1 1/2"	8'	No	67	56	41	15	-	-	21'
EX6100	98	3.1*	115/230	.77¢	1 1/2"	8'	No	92	79	65	40	-	-	23'
EX8800	98	4.0*	115/230	.99¢	2"	8'	No	130	108	84	48	-	-	23'
EXP3700	99	2.8*	115/230	.69¢	2"	8'	Yes	54	38	25	8	-	-	21'
EXP4900	99	3.4*	115/230	.84¢	2"	8'	Yes	73	60	46	23	-	-	21'
EXP6800	99	3.9*	115/230	.97¢	2"	8'	Yes	96	80	52	-	-	-	19'
EXP7800	99	5.0*	115/230	\$1.24	2"	8'	Yes	118	101	81	53	-	-	24'

* Maximum amps at 115v

High Head Pumps

Part #	Pg #	Amps	Volts	Cost for 24 hrs	Outlet Pipe Size	Cord Length	Self Priming	Flow Rates @ Feet of Head					Max Head	
								20'	30'	40'	50'	60'		70'
EX8500	98	5.4	230	\$2.68	1 1/2"	8'	No	116	100	80	51	-	-	55'
EX11000	98	8.6	230	\$4.27	1 1/2"	8'	No	-	143	125	106	80	33	72'
EXP6300HP	99	8.7	230	\$4.32	2"	8'	Yes	89	80	70	61	46	26	77'
EXP9300HP	99	11.4	230	\$5.66	2"	8'	Yes	-	121	114	100	86	66	83'
EX11200	98	9.6	230	\$4.77	2"	8'	No	-	-	138	122	102	75	80'
EX13200	98	11.5	230	\$5.71	2"	8'	No	-	-	175	150	141	117	80'



See our website for more information on selecting pumps



Tips for operating an External Pump:

Proper plumbing selection and set up is important when choosing to use an external pump. There are two basic set ups with an external pump: flooded suction or suction lift. A flooded suction set up is where the pump is situated below the water level and the water flows by gravity to the pump. A suction lift set up is where the pump is located above the water level. "Suction lift" is a technical term for this set up, it does not mean that the pump acts like a vacuum cleaner. To the right are some ways to set up an external pump with a skimmer. There are limits to how high a pump can be placed in a suction lift set up. Each pump is different, but these general layouts show how an external pump can be used.

Improper Plumbing Setup

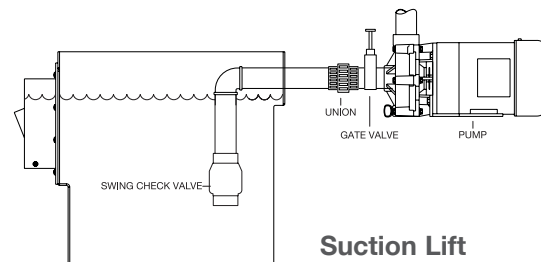
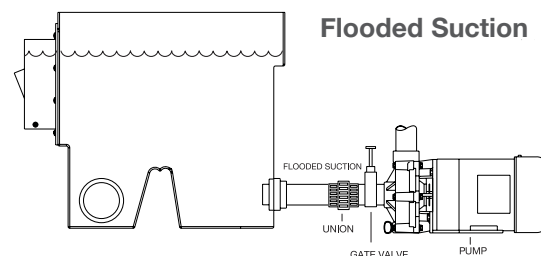
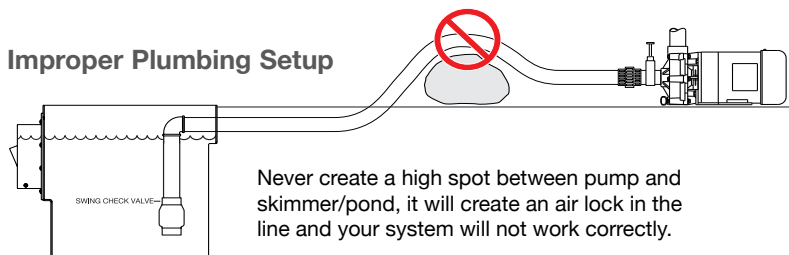



External Low Head Pumps

Ideal for koi ponds, external filters and low head water falls, these reliable pumps are a great value!

- Continuous duty, weatherproof motors — can be used outdoors without additional protection from weather
- 8' power cord included
- Not self-priming — use in flooded suction applications or with check valve on suction line to maintain prime
- All sizes (except EX3600) have dual voltage motors, pumps are shipped 115v but can easily be field changed to 230v

Part #	Watts	Max. Flow GPH	Max. Amps 115v	Inlet/ Outlet	GPM @ Feet of Head				Max. Head	Limited Warranty	Stocking Code	Ship Weight	List Price
					5'	10'	15'	20'					
EX3600	139	3600	1.4	2"/1½"	52	34	-	-	12'	18 months	8301122	21 lbs.	\$401.49
EX4500	252	4500	2.7	1½"	67	56	41	15	21'	18 months	5331420	25 lbs.	\$441.89
EX6100	366	6100	3.1	1½"	92	79	65	40	23'	18 months	1368244	25 lbs.	\$490.99
EX8800	449	8200	4.4	2"	120	103	84	48	22'	3 Years	6570973	32 lbs.	\$761.29



External High Head Pumps

The perfect choice for tall waterfalls, fountain nozzles and long or restrictive plumbing applications!

- Continuous duty, weatherproof motors — can be used outdoors without additional protection from weather, 8' power cord included
- Not self-priming — use in flooded suction applications or with check valve on suction line to maintain prime
- EX8500 and EX11000 have dual voltage motors, pumps are shipped 230v but can easily be field changed to 115v
- EX11200 and EX13200 are 230v only

Part #	Watts	Max. Flow GPH	Max. Amps 230v	Inlet/ Outlet	GPM @ Feet of Head						Max. Head	Limited Warranty	Stocking Code	Ship Weight	List Price
					20'	30'	40'	50'	60'	70'					
EX8500	1385	8500	5.4	1½"	116	100	80	51	-	-	55'	3 Years	7618591	50 lbs.	\$824.79
EX11000	2056	11000	8.6	1½"	-	143	125	106	80	33	72'	3 Years	4716179	53 lbs.	\$954.89
EX11200	2162	11200	9.6	2"	-	-	138	122	102	75	80'	3 Years	8786070	63 lbs.	\$1048.09
EX13200	2595	13200	11.5	2"	-	-	175	150	141	117	80'	3 Years	3822892	68 lbs.	\$1097.19

Optional Strainer Baskets for EX Pumps



- Use as a prefilter before the pump
- Can be used with other brand pumps
- Clear lids for easy inspection
- Includes unions on inlet/outlet for easy removal of pump



Removable strainer basket

Part #	Size	Inlet/Outlet	Stocking Code	Ship Weight	List Price
EXS901	90 cu. in.	1½"	782129	5 lbs.	\$109.49
EXS902	90 cu. in.	2"	282120	5 lbs.	\$109.49



Pumps



Self Priming, Low Head External Pumps

- Rugged, weatherproof motors are energy efficient and long lasting
- All sizes have dual voltage motors with 8' power cord, pumps are shipped 115v but can easily be field changed to 230v
- Very quiet operation
- Built-in 90 cubic inch strainer basket
- Includes free inlet/outlet unions



Part #	Max. Watts	Max. Flow GPH	Max. Amps 115v	Inlet/Outlet	GPM @ Feet of Head				Max. Head	Limited Warranty	Stocking Code	Ship Weight	List Price
					5'	10'	15'	20'					
EXP3700	228	3700	2.7	2"	54	38	25	8	21'	3 Years	7675441	53 lbs.	\$900.59
EXP4900	310	4900	3.3	2"	73	60	46	23	21'	3 Years	4717979	53 lbs.	\$957.29
EXP6800	369	6800	3.9	2"	96	80	52	-	19'	3 Years	9755243	58 lbs.	\$1006.99
EXP7800	504	7800	5.0	2"	118	101	81	53	24'	3 Years	5762292	58 lbs.	\$1016.39



Self Priming, High Head External Pumps

- Powerful, continuous duty motors capable of over 75' of head pressure!
- Ideal for formal fountains and other applications needing high pressure
- Built-in 90 cubic inch strainer basket
- All sizes have dual voltage motors with 8' power cord, pumps are shipped 230v but can easily be field changed to 115v
- Includes free inlet/outlet unions



Part #	Max. Watts	Max. Flow GPH	Max. Amps 230v	Inlet/Outlet	GPM @ Feet of Head						Max. Head	Limited Warranty	Stocking Code	Ship Weight	List Price
					20'	30'	40'	50'	60'	70'					
EXP6300HP	1496	6300	8.7	2"	89	80	70	61	46	26	77'	3 Years	6794690	63 lbs.	\$1059.59
EXP9300HP	2222	9300	11.4	2"	-	121	114	100	86	66	83'	3 Years	3828448	63 lbs.	\$1104.59



See our website for more information on selecting pumps



High Volume Continuous Duty Pumps

- Weatherproof design ensures high performance and years of trouble-free service
- Ideal for large features — delivers high performance in a compact design
- 3/4 HP pumps operate on 115v or 230v
- 3/4 HP includes 8' power cord and is wired 115v - can be field changed to 230v, EXT180 and larger are hard wired and do not include power cord



Part #	HP	Max. Flow GPH	Max. Amps 230v	Inlet/Outlet	GPM @ Feet of Head									Max. Head	Stocking Code	Ship Weight	List Price
					5'	10'	15'	20'	30'	40'	60'	80'	100'				
EXT75	3/4	12500	6	3 1/2"	192	170	131	70	-	-	-	-	-	21'	91098220	84 lbs.	\$1464.29
EXT180	1.8**	15200	7	3 1/2"	237	216	190	166	80	-	-	-	-	31'	11553924	110 lbs.	\$2071.89
EXT300	3	18400	11	3 1/2"	-	275	256	238	192	125	-	-	-	45'	21543728	110 lbs.	\$2058.29
EXT3FK	Flange kit for EXT75, EXT180 and EXT300 pumps										-	587747	8 lbs.	\$116.99			

**Motor is 3 hp but operates at 1.8 hp rating

Artesian Pro Pumps



These pumps offer higher flow rates and higher head pressures



They are ideal for medium flow, medium head applications where the safety of an external pump and the convenience of a self primer are desired.

- Self priming — will prime up to 5' above water level (must prime on initial start-up)
- 3" inlet/outlet unions included
- Extra large strainer basket — reduces cleaning frequency
- Very quiet motors — open drip proof design does require protection from weather
- Dual voltage motor (115/230) on 3/4 HP — 1.5 and 3 HP are 208-230 volt only

Part #	HP	Max. Flow GPH	Max. Amps /Volts	Inlet/Outlet	GPM @ Ft. of Head						Max Head	Limited Warranty	Stocking Code	Ship Weight	List Price
					0'	10'	20'	30'	40'	50'					
PCA75	3/4	10980	5.5/230v	3"	183	161	129	90	-	-	39'	3 Years	3906747	61 lbs.	\$1169.99
PCA150	1.5	13560	9.2/230v	3"	-	226	195	163	113	-	48'	3 Years	61053995	66 lbs.	\$1359.99
PCA300	3	18300	13.4/230v	3"	-	305	276	236	196	145	58'	3 Years	71224492	67 lbs.	\$1579.99
PCA500	5	19740	17.6/230v	3"	-	-	312	282	246	202	65'	3 Years	11441494	75 lbs.	\$1859.99

3/4 HP pump includes 6' power cord. 1.5, 3 and 5 HP pumps do not include cord



Variable Speed Pump

Adjust the flow and maximize energy savings

- Low energy consumption due to high efficiency pump and motor
- 230 volt single phase power input
- Three phase motor is totally enclosed and fan cooled for maximum protection and reliability
- Variable speed allows regulation of performance — when the flow rate is lowered, the operating cost is lowered as well
- Get extra pressure when needed for back washing filters
- Use the extra flow to up-size the water feature when needed
- 3" inlet/outlet, unions included



Part #	Maximum HP	Max. Flow GPH	Maximum Flow at High RPM*					Max. Head	Limited Warranty	Stocking Code	Ship Weight	List Price
			10'	20'	30'	40'	50'					
PCA270D	2.7	250	245	220	190	145	30	50'	1 year	72169998	66 lbs.	\$2799.99

*Flows will be reduced as motor speed is reduced



IRRI-GATOR™ Pumps by Goulds

- Features include fast self priming action, compact lightweight design, high pressure capabilities and heavy duty construction
- 115/230 volt motors available on all pumps except 2 HP and 3 HP (230 volt only)

Part #	HP	Amps @ 230 Volts	Inlet/Outlet	GPM Flow @ Feet of Head					Power Cord	Limited Warranty	Stocking Code	Ship Weight	List Price
				20'	40'	60'	80'	100'					
GT07	3/4	7.4	1 1/2"	46	44	41	30	10	6'	1 Year	7462826	46 lbs.	\$617.09
GT10	1	8.1	1 1/2"	60	56	48	40	28	6'	1 Year	3477822	49 lbs.	\$637.09
GT15	1.5	11	1 1/2"	64	62	60	56	42	6'	1 Year	4516374	58 lbs.	\$688.49
GT20	2	11.3	1 1/2"	88	86	84	76	63	6'	1 Year	6698993	63 lbs.	\$931.99
GT30	3	15.2	1 1/2"	110	107	102	89	73	6'	1 Year	81050075	74 lbs.	\$1400.09



High Volume, Low-Head Pumps by Goulds

- Totally enclosed, fan cooled motors — can be used outdoors without further protection
- All motors can be wired 115, 208 or 230 volts, except 5 HP must be 208 or 230 only
- Discharge of pump can be rotated 90° to accommodate plumbing
- Stainless steel shaft and wear plate for long life
- Not self priming — use a check valve on suction line for self priming applications



Our largest 115v external pumps!

Adventure Developments (IA)

Part #	HP	230v Amps	Inlet/Outlet	RPM	GPM Flow @ Feet of Head							Power Cord	Limited Warranty	Stocking Code	Ship Weight	List Price
					5'	10'	15'	20'	25'	30'	35'					
GCP05	.5	3.8	3"	1725	200	125	-	-	-	-	-	6'	12 months	51300943	72 lbs.	\$1734.59
GCP10	1	6	2 1/2"	3450	-	210	160	100	-	-	-	6'	12 months	71412094	78 lbs.	\$1882.79
GCP15	1.5	8	2 1/2"	3450	-	230	200	160	115	-	-	none	12 months	21443826	85 lbs.	\$1925.09
GCP20	2	11.5	3"	3450	-	-	310	250	200	-	-	none	12 months	61523992	100 lbs.	\$2031.99
GCP30	3*	14.5	4"	3450	-	-	425	375	200	-	-	none	12 months	72154224	175 lbs.	\$2872.29
GCP50**	5*	19.5	4"	3450	-	-	-	540	500	460	400	none	12 months	92283593	175 lbs.	\$3044.79
GCP30FK	4" fpt flange with hardware and gasket for GCP30/50 outlet											-	-	578740	8 lbs.	\$104.99
GCP30FKI	4" fpt flange with hardware and gasket for GCP30/50 inlet											-	-	378749	8 lbs.	\$104.99

*GCP30 and GCP50 have flanged inlet/outlet, flanges not included — please purchase separately above

**GCP50 is available as 230v only



High Volume Centrifugal Pumps

Berkeley pumps are known world wide for their high performance and reliable, continuous duty operation

Hundreds of models to choose from — contact us with your project needs and Berkeley's computerized pump selector program will choose the best pump for your application.

- Higher head pumps (up to 200' high) are available at lower flows
- Single phase power pumps shown — **three phase pumps and many other models available, please inquire!**



Single Phase Pumps, 3-10 HP with High Volume Impellers

Part #	HP	230v Amps	Inlet/Outlet	GPM Flow @ Feet of Head							Limited Warranty	Stocking Code	Ship Weight	List Price
				15'	20'	25'	30'	35'	40'	45'				
BC50	5	28	4"/3"	-	-	-	450	420	380	300	1 Year	72941573	220 lbs.	\$3922.09
BC500*	5	28	6"/5"	760	600	380	-	-	-	-	1 Year	54770379	285 lbs.	\$6360.49
BC75	7.5	35.2	4"/3"	-	-	-	-	560	530	500	1 Year	43380547	260 lbs.	\$4507.39
BC750*	7.5	35.2	6"/5"	-	900	790	675	550	-	-	1 Year	85194192	325 lbs.	\$6925.59
BC100*	10	44	8"/6"	-	1300	1150	750	-	-	-	1 Year	34136924	315 lbs.	\$5515.89

*Flange is needed to connect to proper size pipe — call for pricing and availability



Huge inventory for immediate shipment!

PRO SERIES

This industrial strength flexible PVC pipe is ideal for waterfall lines, recirculating system lines and air distribution lines. Use this pipe in tight areas to eliminate 90° elbows and improve flow rates.

- All sizes will glue into Schedule 40 PVC fittings — no special fittings or glue required
- Very flexible — temperature range is -10°F to 130°F
- Eliminates back pressure caused by sharp turns in standard PVC fittings and increases flow
- Increases efficiency of system while reducing fittings and installation time

Flex pipe can be purchased per foot, per 25' roll, per 50' roll or per 100' roll.

All rolls up to 2" can ship UPS. 3" and larger rolls must ship via motor freight.



We offer one of the largest selections of sizes anywhere in the country!

PER FOOT

Part #	Size	Stocking Code	List Price
FP50F	1/2"	21584	\$2.35
FP75F	3/4"	41712	\$2.54
FP100F	1"	51837	\$2.71
FP125F	1 1/4"	72109	\$3.11
FP150F	1 1/2"	12210	\$3.27
FP200F	2"	33393	\$5.02
FP300F	3"	66154	\$9.11
FP400F	4"	812897	\$19.83
FP600F	6"	526739	\$41.12

PER 25' ROLL

Part #	Size	Stocking Code	Ship Weight	List Price
FP5	1/2"	427747	4 lbs.	\$41.09
FP7	3/4"	629964	6 lbs.	\$44.39
FP10	1"	132066	8 lbs.	\$47.49
FP12	1 1/4"	736783	11 lbs.	\$54.49
FP15	1 1/2"	338609	13 lbs.	\$57.19
FP20	2"	659337	19 lbs.	\$87.89
FP30	3"	5107665	32 lbs.	\$159.49
FP40	4"	8225542	48 lbs.	\$346.99
FP60	6"	7467738	105 lbs.	\$719.59

PER 50' ROLL

Part #	Size	Stocking Code	Ship Weight	List Price
FP50	1/2"	655488	11 lbs.	\$82.19
FP75	3/4"	259876	12 lbs.	\$88.69
FP100	1"	464057	16 lbs.	\$94.89
FP125	1 1/4"	573504	21 lbs.	\$108.89
FP150	1 1/2"	277218	26 lbs.	\$114.39
FP200	2"	7118669	37 lbs.	\$175.79
FP300	3"	2215253	61 lbs.	\$318.89
FP400	4"	9451035	95 lbs.	\$693.89
FP600	6"	1935414	210 lbs.	\$1439.09

PER 100' ROLL**

Part #	Size	Stocking Code	Ship Weight	List Price
FP501	1/2"	4110960	16 lbs.	\$164.39
FP751	3/4"	3119678	24 lbs.	\$177.29
FP1001	1"	7128114	32 lbs.	\$189.79
FP1251	1 1/4"	2147017	43 lbs.	\$217.79
FP1501	1 1/2"	5154436	50 lbs.	\$228.79
FP2001*	2"	4237325	75 lbs.	\$351.59
FP3001	3"	1430513	122 lbs.	\$637.79

**Due to size and weight, 4" and 6" rolls not available in 100' length



Flexible PVC Pipe ECO-Series®

- Very flexible — works well in tight or confined areas
- Works with regular PVC glue and fittings, smooth inside and outside
- Strengthened with internal anti shock PVC spiral for maximum durability!
- Manufactured with 100% virgin materials, crush and impact resistant, UV protected

Part #	Size	Pallet Quantity	Stocking Code	Ship Weight	List Price
FP15N	1 1/2" x 25'	40	631588	11 lbs.	\$46.79
FP150N*	1 1/2" x 50'	24	163111	22 lbs.	\$93.49
FP1501N*	1 1/2" x 100'	12	7126153	44 lbs.	\$186.89
FP20N	2" x 25'	30	544612	20 lbs.	\$66.09
FP200N*	2" x 50'	18	989230	28 lbs.	\$132.19
FP2001N*	2" x 100'	9	4172256	56 lbs.	\$255.19

Maximum recommended flow rates for tubing and flexible PVC pipe:

1/2"	8 gpm (480 gph)
3/4"	15 gpm (900 gph)
1"	25 gpm (1,500 gph)
1 1/4"	45 gpm (2,700 gph)
1 1/2"	60 gpm (3,600 gph)
2"	90 gpm (5,400 gph)
3"	225 gpm (13,500 gph)
4"	350 gpm (21,000 gph)
6"	700 gpm (42,000 gph)

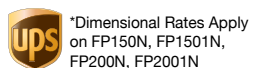



Kink Free Tubing in US & Metric Sizes

- High quality kink free tubing is a popular choice for pond and water garden applications
- Smooth inside for maximum flow, ribbed outside for increased strength
- Temperature range of -15°F to 190°F
- Available in metric sizing (black) and US sizing (gray)
- Sold two ways — spools for easy retail dispensing or bulk for maximum savings!
- 100' lengths up to 1 1/2", 2" available only in 50' lengths



BULK TUBING - NO SPOOL



Part #	Size	Similar US Size	Roll Length	Stocking Code	Ship Weight	List Price
MNK07B	19 mm	3/4"	100'	476743	15 lbs.	\$113.69
MNK10B	25 mm	1"	100'	785522	17 lbs.	\$126.69
MNK12B	32 mm	1 1/4"	100'	9112525	24 lbs.	\$166.69
MNK15B	38 mm	1 1/2"	100'	3117046	30 lbs.	\$173.39
MNK20B	51 mm	2"	50'	683294	38 lbs.	\$123.39
UNK07B	3/4"	-	100'	476748	15 lbs.	\$113.69
UNK10B	1"	-	100'	585524	17 lbs.	\$126.69
UNK12B	1 1/4"	-	100'	7112522	24 lbs.	\$166.69
UNK15B	1 1/2"	-	100'	6117040	30 lbs.	\$173.39
UNK20B	2"	-	50'	883293	38 lbs.	\$123.39

TUBING ON SPOOLS



Part #	Size	Similar US Size	Roll Length	Stocking Code	Ship Weight	List Price
MNK07	19 mm	3/4"	100'	495303	15 lbs.	\$141.19
MNK10	25 mm	1"	100'	7103472	17 lbs.	\$153.29
MNK12	32 mm	1 1/4"	100'	9130475	24 lbs.	\$193.29
MNK15	38 mm	1 1/2"	100'	3140606	30 lbs.	\$208.29
MNK20	51 mm	2"	50'	6106854	38 lbs.	\$158.29
UNK07	3/4"	-	100'	495308	15 lbs.	\$141.19
UNK10	1"	-	100'	5103474	17 lbs.	\$153.29
UNK12	1 1/4"	-	100'	7130472	24 lbs.	\$193.29
UNK15*	1 1/2"	-	100'	6140600	30 lbs.	\$208.29
UNK20*	2"	-	50'	8106853	38 lbs.	\$158.29

Pipe Comparison

Proper tubing selection is critical to pump performance

A pump will only perform to the capacity of the plumbing system it is connected to — it's critical that your plumbing system is sized to carry the volume of water your system needs.

Many people mistakenly think that there really isn't much difference between (for example) 1 1/2" and 2" pipe or between 3" to 4" pipe. The chart below shows how many square inches of surface area are on the inside of flexible PVC pipe.

Pipe Size (dia.)	Square Inches of Surface Area
1"	.79
1 1/2"	1.77
2"	3.14
3"	7.07

Pipe Size (dia.)	Square Inches of Surface Area
4"	12.57
6"	28.27
8"	50.26



As you can see, there is a big difference between 1 1/2" and 2" pipe — almost 80% more space! This shows why using the correct size pipe is important to the output of your pump.

Prepackaged 12' Rolls Metric Tubing

Ideal for Retail Sales



- Precut lengths are ideal for use with mag drive pumps and filters

Part #	Size	Similar US Size	Stocking Code	Ship Weight	List Price
MNK0712	19 mm	3/4"	314780	3 lbs.	\$21.89
MNK1012	25 mm	1"	216602	3 lbs.	\$24.59
MNK1212	32 mm	1 1/4"	520928	4 lbs.	\$30.99
MNK1512	38 mm	1 1/2"	622541	5 lbs.	\$33.39

Vinyl Tubing

- Available in clear or black, smooth inside & outside!
- Use on air compressor lines, blower lines, water circulation, and more
- Flexible tubing has a temperature range of 5°F to 150°F
- 3/8" - 1/2" black tubing has 1/16" wall; 5/8" - 1" black tubing has 1/8" wall thickness

Part #	Description	Stocking Code	Ship Weight	List Price
BVT375	3/8" x 100', black	227677	4 lbs.	\$40.99
BVT500	1/2" x 100', black	734821	6 lbs.	\$51.59
BVT625	5/8" x 100', black	369325	8 lbs.	\$102.69
BVT750	3/4" x 100', black	481403	17 lbs.	\$120.59
BVT1000	1" x 100', black	5117440	23 lbs.	\$173.99
VT375	3/8" x 100', clear vinyl	627671	4 lbs.	\$40.99
VT500	1/2" x 100', clear vinyl	432464	5 lbs.	\$48.09





"QUALITY BY DESIGN"

SAVE 5% ON A CASE!

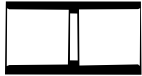

DEEP SOCKET COUPLINGS (SLP X SLP)

Part #	Size	Stocking Code	Full Box Quantity	List Price
CO05	1/2"	2581	250	\$0.89
CO07	3/4"	4717	250	\$1.09
CO10	1"	81032	100	\$1.59
CO12	1 1/4"	91236	50	\$1.89
CO15	1 1/2"	11297	50	\$1.99
CO20	2"	61943	25	\$2.99
CO30	3"	24411	10	\$6.79
CO40	4"	74870	6	\$7.49
CO60	6"	814102	4	\$21.69
CO80	8"	424047	5	\$36.99



REDUCER BUSHINGS (SPG X SLP)

Part #	Size	Stocking Code	Full Box Quantity	List Price
RB3412	3/4" x 1/2"	1640	250	\$0.99
RB1034	1" x 3/4"	21101	250	\$1.69
RB1210	1 1/4" x 1"	41497	150	\$2.29
RB1510	1 1/2" x 1"	51553	100	\$2.39
RB1512	1 1/2" x 1 1/4"	81551	100	\$2.39
RB2010	2" x 1"	22406	50	\$3.69
RB2012	2" x 1 1/4"	92407	50	\$3.69
RB2015	2" x 1 1/2"	62408	50	\$3.69
RB3015	3" x 1 1/2"	54150	25	\$6.39
RB3020	3" x 2"	34151	25	\$6.39
RB4020	4" x 2"	16437	10	\$9.89
RB4030	4" x 3"	76430	10	\$9.89
RB6040	6" x 4"	313770	4	\$21.19
RB8060	8" x 6"	142183	2	\$64.89

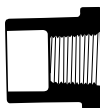

REDUCER BUSHINGS (SPG X FPT)

Part #	Size	Stocking Code	Full Box Quantity	List Price
RBT3412	3/4" x 1/2"	11161	500	\$1.79
RBT1034	1" x 3/4"	81550	250	\$2.39
RBT1210	1 1/4" x 1"	32337	150	\$3.59
RBT1510	1 1/2" x 1"	42729	100	\$4.19
RBT1512	1 1/2" x 1 1/4"	12722	100	\$4.19
RBT2010	2" x 1"	43445	50	\$5.29
RBT2015	2" x 1 1/2"	13449	50	\$5.29
RBT3020	3" x 2"	73968	25	\$6.09
RBT4030	4" x 3"	37400	25	\$11.39

Plumbing Terms:

- SLP:** Slip (smooth)
- FPT:** Female Threads
- MPT:** Male Threads
- SPG:** Spigot Fitting (fits inside of coupling)

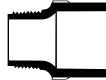

MALE ADAPTERS (MPT X SLP)

Part #	Size	Stocking Code	Full Box Quantity	List Price
MA05	1/2"	2771	250	\$1.19
MA07	3/4"	4907	250	\$1.39
MA10	1"	91422	100	\$2.19
MA12	1 1/4"	71498	50	\$2.29
MA15	1 1/2"	81887	50	\$2.89
MA20	2"	62079	25	\$3.19
MA30	3"	35321	16	\$8.19
MA40	4"	46823	12	\$10.49
MA60	6"	214167	3	\$21.79
MA80	8"	153492	4	\$82.29



FEMALE ADAPTERS (FPT X SLP)

Part #	Size	Stocking Code	Full Box Quantity	List Price
FA05	1/2"	6971	250	\$1.49
FA07	3/4"	91233	250	\$1.89
FA10	1"	11298	100	\$1.99
FA12	1 1/4"	21496	50	\$2.29
FA15	1 1/2"	71751	50	\$2.69
FA20	2"	82147	25	\$3.29
FA30	3"	15712	10	\$8.79
FA40	4"	67928	5	\$12.19
FA60	6"	833036	5	\$47.19
FA80	8"	547191	4	\$84.79



CAPS (SLIP)

Part #	Size	Stocking Code	Full Box Quantity	List Price
CAP05	1/2"	2777	250	\$1.19
CAP07	3/4"	1843	250	\$1.29
CAP10	1"	51102	250	\$1.69
CAP12	1 1/4"	61425	125	\$2.19
CAP15	1 1/2"	11620	50	\$2.49
CAP20	2"	51887	50	\$2.89
CAP30	3"	34618	15	\$7.09
CAP40	4"	87791	9	\$11.99
CAP60	6"	216630	3	\$25.59
CAP80	8"	431327	2	\$48.19

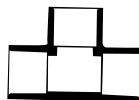

DEEP SOCKET TEES (SLP X SLP X SLP)

Part #	Size	Stocking Code	Full Box Quantity	List Price
TE05	1/2"	9907	150	\$1.39
TE07	3/4"	31032	100	\$1.59
TE10	1"	21626	50	\$2.49
TE12	1 1/4"	52071	40	\$3.19
TE15	1 1/2"	62538	25	\$3.89
TE20	2"	33187	15	\$4.89
TE30	3"	87990	5	\$12.29
TE40	4"	212413	3	\$19.09
TE60	6"	438806	2	\$59.69
TE80	8"	186778	2	\$133.49

PVC Primer/Glue

- Medium bodied, fast setting
- For use on pipe up to 8" diameter
- Formulated for wet conditions
- Primer is recommended to clean pipe to ensure good glue bond



Part #	Size	Case Quantity	Stocking Code	List Price
G4	4 oz.	24	64227	\$6.49
G8	8 oz.	24	24745	\$7.29

GLUE

G4	4 oz.	24	64227	\$6.49
G8	8 oz.	24	24745	\$7.29

PRIMER

PR4	4 oz.	24	54023	\$6.19
PR8	8 oz.	24	75191	\$7.99

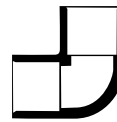

90° ELBOWS (SLP X SLP)

Part #	Size	Stocking Code	Full Box Quantity	List Price
EL05	1/2"	3906	250	\$1.39
EL07	3/4"	2971	150	\$1.49
EL10	1"	61498	50	\$2.29
EL12	1 1/4"	22070	50	\$3.19
EL15	1 1/2"	62208	50	\$3.39
EL20	2"	33241	20	\$4.99
EL30	3"	66560	8	\$10.09
EL40	4"	110599	3	\$16.29
EL60	6"	524690	2	\$37.99
EL80	8"	261357	2	\$94.39

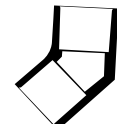

45° ELBOWS (SLP X SLP)

Part #	Size	Stocking Code	Full Box Quantity	List Price
ELL05	1/2"	9970	250	\$1.49
ELL07	3/4"	61361	100	\$2.09
ELL10	1"	21680	100	\$2.59
ELL12	1 1/4"	42147	50	\$3.29
ELL15	1 1/2"	82729	50	\$4.19
ELL20	2"	52988	20	\$4.59
ELL30	3"	18519	8	\$13.09
ELL40	4"	413060	3	\$20.09
ELL60	6"	626771	2	\$41.19
ELL80	8"	357976	2	\$89.19

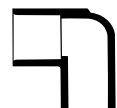

90° STREET ELBOW (SLP X SPG)

Part #	Size	Stocking Code	Full Box Quantity	List Price
STL05	1/2"	31810	250	\$2.79
STL07	3/4"	72278	150	\$3.49
STL10	1"	22989	50	\$4.59
STL12	1 1/4"	63570	50	\$5.49
STL15	1 1/2"	93963	50	\$6.09
STL20	2"	45457	20	\$8.39
STL30*	3"	416307	10	\$23.29

*No case discount available

SCHEDULE 40 BLACK PVC FITTINGS

We offer the three most popular PVC fittings in black. Available in 1 1/2" and 2" sizes. Compatible with flex PVC using normal PVC glue.

Part #	Size	Description	Case Quantity	Stocking Code	Ship Weight	List Price
MAB15	1 1/2"	Male Adapter	50	62017	1 lb.	\$3.09
MAB20	2"	Male Adapter	25	42141	1 lb.	\$3.29
ELB15	1 1/2"	90° Elbow	50	32279	1 lb.	\$3.49
ELB20	2"	90° Elbow	20	23448	1 lb.	\$5.29
COB15	1 1/2"	Coupling	50	51490	1 lb.	\$2.29
COB20	2"	Coupling	25	92076	1 lb.	\$3.19



REDUCER COUPLING

Reduces PVC pipe down in size in one smooth step. Less back pressure than using a coupling with reducer bushing.

Part #	Size	Stocking Code	List Price
REC32	3" x 2"	218057	\$25.79
REC43	4" x 3"	522532	\$32.19
REC63	6" x 3"	751446	\$73.49
REC64	6" x 4"	529744	\$42.49
REC86	8" x 6"	452706	\$75.29



ECCENTRIC REDUCER COUPLING

Use when reducing larger size plumbing down to pump inlet. Helps prevent turbulence going into the pump which can cause cavitation.

Part #	Size	Stocking Code	List Price
ERC43	4" x 3"	631637	\$45.19
ERC64	6" x 4"	535556	\$50.79
ERC86	8" x 6"	958094	\$82.99



SCHEDULE 80 PVC NIPPLES

Male threads on both ends

Part #	Dia. x Length	Stocking Code	Ship Weight	List Price
DN104	1" x 4"	81030	1 lb.	\$1.59
DN125	1 1/4" x 5"	52531	1 lb.	\$3.89
DN155	1 1/2" x 5"	82597	1 lb.	\$3.99
DN205	2" x 5"	73373	1 lb.	\$5.19
DN208	2" x 8"	64670	2 lbs.	\$7.19
DN306	3" x 6"	17476	2 lbs.	\$11.49
DN408	4" x 8"	211958	3 lbs.	\$18.39



PVC UNIONS

SLIP x SLIP union glues onto PVC pipe or flex pipe.

Part #	Size	Stocking Code	List Price
UN1	1 1/2"	47482	\$10.69
UN2	2"	310424	\$14.89
UN3	3"	728929	\$44.49
UN4	4"	240036	\$61.59
UN6	6"	8148532	\$212.19



SUCTION STRAINERS



Use these polypropylene strainers to keep fish, rocks, sticks, etc. out of intakes on external pumps.

Part #	Inlet Size	Stocking Code	Ship Weight	List Price
SSP15	1 1/2"	49689	1 lb.	\$14.89
SSP20	2"	610785	1 lb.	\$16.59
SSP30	3"	722426	2 lbs.	\$34.49

SPECIALTY FITTINGS

Part #	Size	Stocking Code	List Price
SLP x SLP x FPT			
RTE15	1 1/2" x 1 1/2" x 1/2"	63111	\$4.79
RTE20	2" x 2" x 1/2"	43893	\$5.99
SLP x SLP x SLP			
RT1510	1 1/2" x 1 1/2" x 1"	42593	\$3.99
RT2015	2" x 2" x 1 1/2"	52536	\$3.89
RT3020	3" x 3" x 2"	79424	\$14.49
RT4030	4" x 4" x 3"	815662	\$24.09
MPT x SLP			
RMA1520	2" x 1 1/2"	62988	\$4.59
MPT X SLP			
RM142	1 1/4" x 1 1/2"	32201	\$3.39
RM122	1 1/2" x 2"	72663	\$4.09
RM253	2 1/2" x 3"	812038	\$17.19

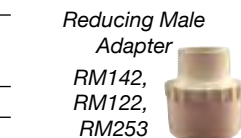

3-Way CPVC Valves

- Ability to rotate valve for inlet options
- Proportional flow control
- Easy to turn and secure valve
- 50 psi maximum working pressure



Part #	Size	Stocking Code	Ship Weight	List Price
TWV15N	1 1/2"	234121	2 lbs.	\$52.49
TWV20N	2"	136394	2 lbs.	\$55.99

PVC Gate Valves

- The popular choice for open/close applications like hauling tank drains, multiple pipelines, water flow control between pump, filters, drains, etc. and most low pressure applications
- Body is PVC (except 3" – ABS plastic)



Part #	Size	Max. PSI	Stocking Code	Ship Weight	List Price
GV15	1 1/2"	50	411561	1 lb.	\$17.79
GV20	2"	40	617876	1 lb.	\$27.49
GV30	3"	20	823073	2 lbs.	\$35.49
GV40	4"	18	580145	5 lbs.	\$123.29
GV60	6"	18	2310632	16 lbs.	\$477.89
GV80	8"	18	7411180	20 lbs.	\$632.59

Single Union PVC Ball Valves

Provides an easy spot to disconnect a pump, filter or sterilizer

- Full port ball generates minimum back pressure on pump
- Use in water or air systems up to 150 psi
- Slip x slip connections



Part #	Size	Stocking Code	Ship Weight	List Price
UBV10	1"	98112	1 lb.	\$11.59
UBV15	1 1/2"	416761	1 lb.	\$25.79
UBV20	2"	720014	2 lbs.	\$30.79

Union Check Valve

Built-in Ball Valve

- This assembly gives you a swing check valve, two unions and a ball valve for flow control all in one handy, compact piece
- Available in 1 1/2" or 2" sizes



Part #	Size	Stocking Code	Ship Weight	List Price
BCV15	1 1/2"	327167	2 lbs.	\$41.79
BCV20	2"	139196	2 lbs.	\$60.29

Butterfly Valves

Large valves ideal for use in creating back pressure on large pumps

- Locking handle keeps valve from moving due to high flow or vibration
- Use with PVC flanges on page 108, each valve needs a flange on both sides to glue onto PVC pipe and an 8" bolt set



Part #	Size	Stocking Code	Ship Weight	List Price
BFV6	6"	5214566	8 lbs.	\$330.09
BFV8	8"	2279827	10 lbs.	\$430.49

PVC Ball Valves

Full flow opening and quarter turn operation

- Rated to 150 PSI and feature schedule 80 PVC construction with EPDM seals and seats
- Available in SLP x SLP only

SAVE 5% ON A CASE!



Part #	Size	Case Quantity	Stocking Code	Ship Weight	List Price
BV50	1/2"	15	62931	1 lb.	\$4.19
BV75	3/4"	15	43638	1 lb.	\$5.19
BV100	1"	15	75174	1 lb.	\$7.39
BV125	1 1/4"	10	98381	1 lb.	\$12.89
BV150	1 1/2"	10	39862	1 lb.	\$14.09
BV200	2"	10	212948	2 lbs.	\$18.49
BV300	3"	6	546751	5 lbs.	\$66.79
BV400*	4"	4	6102960	10 lbs.	\$147.09
BV600*	6"	2	8275727	28 lbs.	\$393.89

*Not eligible for case quantity discounts

Heavy Duty Threaded Bulkhead Fittings

These heavy duty bulkhead fittings feature a friction washer between the nut and the tank/liner for more positive sealing

- Inside threads are female pipe thread, use male adapter to connect PVC flex pipe
- Locking nut is a left hand thread (counter clockwise to tighten)
- Thick EPDM gasket between head and tank/liner ensures leak free installations
- See chart below for hole size needed in tank wall for installation



Ideal for Penetrations in Pond Liners!

SAVE 5% ON A CASE!

Part #	Size	Hole Size	Case Quantity	Stocking Code	Ship Weight	List Price
BF50N	1/2"	1 1/2"	25	27411	1 lb.	\$10.59
BF75N	3/4"	1 1/2"	25	67973	1 lb.	\$11.39
BF100N	1"	2 1/4"	25	89097	1 lb.	\$12.99
BF125N	1 1/4"	2 1/4"	20	39449	1 lb.	\$13.49
BF150N	1 1/2"	3"	20	910983	1 lb.	\$15.69
BF200N	2"	3"	20	113578	1 lb.	\$19.39
BF300N	3"	4 5/8"	10	526804	2 lbs.	\$38.29
BF400N	4"	5 3/4"	10	377691	5 lbs.	\$110.99

SLIP x SLIP Bulkhead Fittings

The inside walls of these bulkheads are smooth instead of threaded, allowing you to glue PVC pipe or flex pipe directly into fitting. Eliminates the need for male adapter.



- Right hand threads on locking nut (tightens in clockwise direction)
- Thick rubber gasket ensures water tight seal



SAVE 5% ON A CASE!

Part #	Size	Hole Size	Case Quantity	Stocking Code	Ship Weight	List Price
BF10S	1"	1 3/4"	25	55993	1 lb.	\$9.99
BF15S	1 1/2"	2 1/2"	25	98272	1 lb.	\$13.79
BF20S	2"	2 3/4"	25	10738	1 lb.	\$17.89

PVC Check Valves

Union Style

- Same as SLIP x SLIP with the addition of a union on each end
- The union allows you to glue your line together and still get it apart
- Much more secure connection than rubber couplings in high pressure applications



SLIP x SLIP Style

- These PVC swing check valves are recommended whenever maximum flow is needed
- Swing checks have full flow design for maximum GPM and are completely non-metallic ensuring years of use in water
- Ideal for use in fresh or salt water, are rated to 100 PSI, mount vertical or horizontal, and can be used with schedule 40 or 80 PVC pipe
- SLIP x SLIP only



PVC SWING CHECK VALVES WITH UNIONS:

Part #	Size	Stocking Code	Ship Weight	List Price
UCV15	1 1/2"	717984	2 lbs.	\$25.69
UCV20	2"	227011	3 lbs.	\$38.59
UCV30	3"	657467	4 lbs.	\$82.09

PVC SWING CHECK VALVES WITHOUT UNIONS:

Part #	Size	Stocking Code	Ship Weight	List Price	Part #	Size	Stocking Code	Ship Weight	List Price
SCV10	1"	813712	1 lb.	\$19.59	SCV30	3"	743184	3 lbs.	\$61.69
SCV12	1 1/4"	414203	1 lb.	\$20.29	SCV40	4"	458932	5 lbs.	\$84.19
SCV15	1 1/2"	715048	2 lbs.	\$21.49	SCV60	6"	5137616	13 lbs.	\$196.59
SCV20	2"	323375	2 lbs.	\$33.39	SCV80	8"	2251299	27 lbs.	\$358.99

Flanges

Bolts for Flange Sets

- Each 6" and 8" flange set is bolted together with a set of eight 3/4" bolts
- A bolt set consists of one 3/4" x 4 3/4" bolt with nut and lock washer
- The 10" flange requires twelve bolts 7/8" x 5 3/4", available at your local hardware
- An extra long 3/4" x 8" bolt set is also available for use with butterfly valves (see page 106)



Schedule 80 Pipe Flanges

- Provide an easy disconnect for large plumbing applications
- Bolts not included (sold at left)
- One o-ring flange and one blank flange is needed for each connection
- PVC pipe glues into flange socket

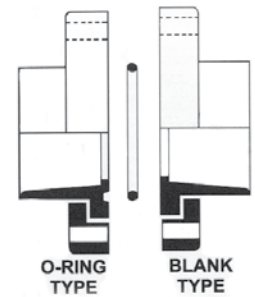

O-RING FLANGE

BLANK FLANGE

Part #	Description	Stocking Code	List Price
BS344	8 sets 4 3/4" Bolts	525754	\$36.79
BS348	8 sets 8" Bolts	342277	\$60.39

Part #	Stocking Code	List Price	Size	Part #	Stocking Code	List Price
OF4	226069	\$40.09	4"	BFL4	121578	\$33.19
OF6	541014	\$63.09	6"	BFL6	633996	\$52.29
OF8	362006	\$95.39	8"	BFL8	966753	\$102.69
OF10	7145927	\$224.49	10"	BFL10	3157100	\$241.69

Nylon Tubing Fittings

Use with vinyl & kink free tubing on page 103 or Quick Sink aeration tubing on page 61



Elbows



Male Adapters



Connectors



Tees

ELBOW (BARB X BARB)

Part #	Size	Stocking Code	List Price
TE25	1/4"	41083	\$1.54
TE38	3/8"	7981	\$1.40
TE50	1/2"	81042	\$1.49
TE75	3/4"	31334	\$1.91
TE100	1"	62340	\$3.34
TE125	1 1/4"	53131	\$4.48
TE150	1 1/2"	23297	\$4.70

MALE ADAPTERS (MPT X BARB)

Part #	Size	Stocking Code	List Price
TA1414	1/4" x 1/4"	6803	\$1.15
TA1438	1/4" x 3/8"	5828	\$1.17
TA1214	1/2" x 1/4"	1907	\$1.28
TA1238	1/2" x 3/8"	9912	\$1.30
TA1212	1/2" x 1/2"	31015	\$1.44
TA3438	3/4" x 3/8"	81040	\$1.49
TA3412	3/4" x 1/2"	11073	\$1.52
TA3434	3/4" x 3/4"	61194	\$1.71
TA1034	1" x 3/4"	21508	\$2.14
TA100	1" x 1"	41769	\$2.52
TA125	1 1/4" x 1 1/4"	82393	\$3.42
TA150	1 1/2" x 1 1/2"	92600	\$3.72

Brass Male Adapters



CONNECTORS (BARB X BARB)

Part #	Size	Stocking Code	List Price
TC1414	1/4" x 1/4"	2773	\$1.10
TC3838	3/8" x 3/8"	7737	\$1.04
TC1212	1/2" x 1/2"	2829	\$1.17
TC3814	3/8" x 1/4"	1860	\$1.23
TC1238	1/2" x 3/8"	9884	\$1.26
TC3434	3/4" x 3/4"	31256	\$1.78
TC100	1" x 1"	81487	\$2.12
TC125	1 1/4" x 1 1/4"	21878	\$2.67
TC150	1 1/2" x 1 1/2"	12314	\$3.30

TEE (BARB X BARB X BARB)

Part #	Size	Stocking Code	List Price
TT25	1/4"	3874	\$1.24
TT38	3/8"	7901	\$1.29
TT50	1/2"	91106	\$1.57
TT75	3/4"	21515	\$2.15
TT100	1"	42078	\$2.96
TT125	1 1/4"	32726	\$3.88
TT150	1 1/2"	63443	\$4.92

BRASS MALE ADAPTERS

Part #	Size	Stocking Code	List Price
BA25	1/4" x 1/4"	61952	\$3.89
BA37	1/4" x 3/8"	92056	\$4.09
BA50	1/4" x 1/2"	22355	\$4.69

Cam Lock Fittings

MALE COUPLING X FEMALE THREAD

- Thread fitting onto a male adapter on the opposite piece of hose from the female coupling below
- This will allow an easily connect and disconnect

Part #	Size	Stocking Code	Ship Weight	List Price
CFA15	1 1/2"	36176	1 lb.	\$9.49
CFA20	2"	67348	1 lb.	\$11.29
CFA30	3"	411822	2 lbs.	\$18.19
CFA40	4"	725996	3 lbs.	\$39.99



Fast, easy disconnect fittings for pumps, hoses, etc. Locking handles ensure watertight seal



FEMALE COUPLING X FEMALE THREAD

- Glue a male adapter on the end of the hose then thread this adapter onto the male adapter, handles lock closed for positive seal

Part #	Size	Stocking Code	Ship Weight	List Price
CFD15	1 1/2"	516506	1 lb.	\$25.39
CFD20	2"	318917	2 lbs.	\$29.09
CFD30	3"	627552	2 lbs.	\$42.39
CFD40	4"	842241	3 lbs.	\$64.99



FEMALE COUPLING X MALE THREAD

Part #	Size	Stocking Code	Ship Weight	List Price
CFB15	1 1/2"	114888	1 lb.	\$22.89
CFB20	2"	217876	2 lbs.	\$27.49
CFB30	3"	726063	2 lbs.	\$40.09
CFB40	4"	439060	3 lbs.	\$60.09



MALE COUPLING X MALE THREAD

- Threads into outlet of pump or into female adapter

Part #	Size	Stocking Code	Ship Weight	List Price
CFF15	1 1/2"	66307	1 lb.	\$9.69
CFF20	2"	26884	1 lb.	\$10.59
CFF30	3"	514620	2 lbs.	\$22.49
CFF40	4"	124176	3 lbs.	\$37.19



REPLACEMENT GASKETS - FEMALE COUPLINGS

Part #	Size	Stocking Code	Ship Weight	List Price
CFG15	1 1/2"	32206	1 lb.	\$3.39
CFG20	2"	12208	1 lb.	\$3.39
CFG30	3"	42469	1 lb.	\$3.79
CFG40	4"	75005	1 lb.	\$7.69



Rubber Couplings

- Heavy duty rubber couplings for joining PVC pipes and flexible PVC pipes together
- Stainless steel clamps on each end ensure a watertight seal
- Ideal for use in repairing broken pipelines underground and for use in lines that will need to be taken apart in the future

Part #	Size	Stocking Code	List Price
RC12	1 1/4"	55137	\$7.89
RC15	1 1/2"	35784	\$8.89
RC20	2"	66495	\$9.99
RC30	3"	48386	\$12.89

Part #	Size	Stocking Code	List Price
RC40	4"	410529	\$16.19
RC215	2" x 1 1/2"	86562	\$10.09
RC32	3" x 2"	77798	\$11.99
RC43	4" x 3"	99166	\$14.09



Valve Boxes

Use these handy boxes to conceal the valve underground and yet have easy access

- The 10" round box is ideal for individual valves, while the 15" x 21" rectangle box is great for multiple valves
- Box is black in color, lids are green
- Lids can be easily covered with mulch to disguise them in landscape areas

Part #	Size	Stocking Code	Ship Weight	List Price
VB10	10" dia x 10" deep	317874	2 lbs.	\$27.49
VB15*	15" x 21" x 12" deep	664808	7 lbs.	\$99.69



Formal water features are becoming more and more popular. EasyPro has extensive experience in this area and can help with designs and materials for these beautiful water features.



Scenic Specialties (MN) built this beautiful formal feature in a "pondless" style.



Landscape Design (MI)



Seasons Gardens (IN) installation at Purdue University



VanBoxel (MI) residential installation



EasyPro has everything you need to build formal fountains from simple designs to world class displays. Since every feature is custom designed, we ask you to contact us with your plan details and we will prepare a quote for you. Due to the complex nature and extreme time included, a nominal fee may be required on some jobs to prepare a quote.



Cross Section of a Typical Formal Fountain

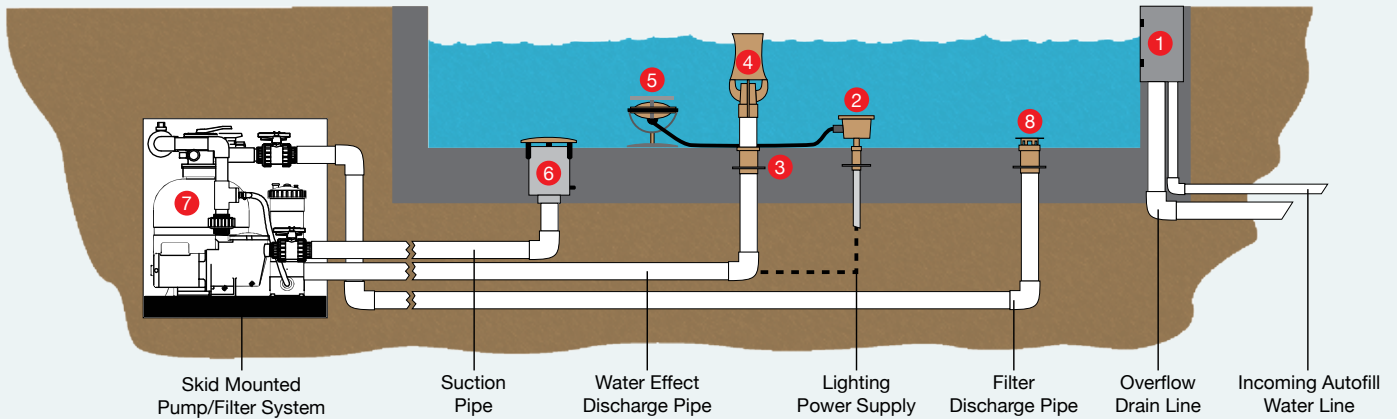

1. Autofill/overflow wall box

Add water for evaporation loss or drain excess rainwater with these flush mount boxes (includes bronze cover)



2. Bronze lighting junction box

Available for one to six lines — combine all lighting cables into one supply box.



3. Water stop flange

Prevents water loss along all PVC pipes penetrating through concrete walls/floor - many sizes available.



4. Spray nozzles

Many styles and sizes to choose from



5. Lighting

Create night time sizzle with underwater lighting



6. Floor drains

Intake water to pump comes from these floor drains

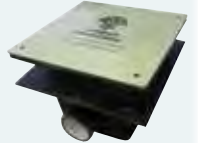

7. Pump/filter

A variety of pumps, filters and chlorinators are available as individual items or turn-key skid mounted systems as shown above



8. Filter return

Excess water from pump/filter is returned up through inlets



We can supply a single piece or complete turn-key system, contact us with all your formal fountain needs



See our website for more information and operation tips



A huge variety of options are available when building formal fountains including:

- Submersible or external pumps
- Nozzle types and quantities
- LED and halogen lighting
- Overflows, autofills and wind sensors

EasyPro can custom build stainless spray rings in a wide variety of sizes and options like this custom unit with (37) 1" Frothy Nozzles

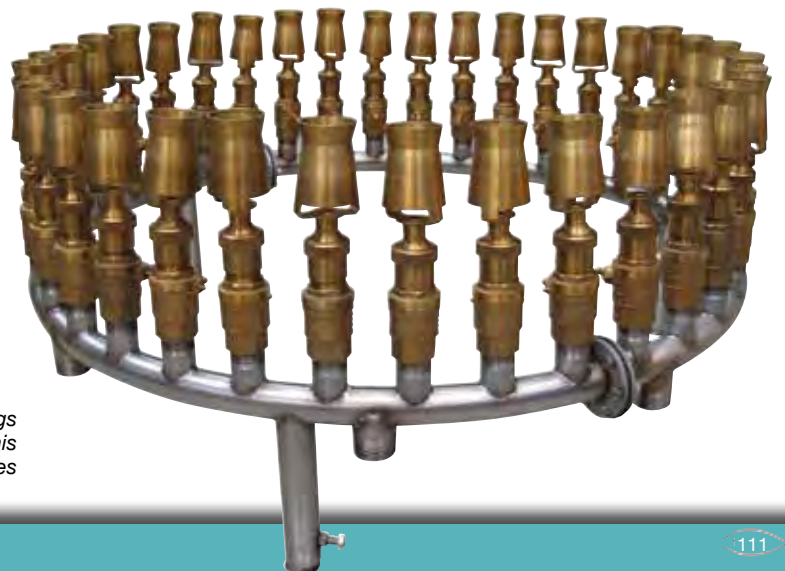



Season's Gardens (IN)

Best Seller!

BRONZE FROTHY NOZZLES

- Popular nozzle produces a thick, foaming geyser that creates an eye catching column of spray, often used in multiple nozzles, each at a different height for a dramatic display
- Due to air being mixed with water at the nozzle, it is important that the water in the pool stays at a constant level
- Built-in bronze swivel allows nozzles to tilt up to 15° in any direction

Part #	Inlet Size	Stocking Code	List Price	Spray Height				
				2' GPM Head	4' GPM Head	6' GPM Head	8' GPM Head	12' GPM Head
FN1	1"	293331	\$143.59	4 10'	8 14'	15 30'	20 44'	- -
FN2	2"	4334875	\$515.19	28 7'	38 16'	42 23'	52 29'	64 38'
FN3	3"	1466767	\$718.09	- -	51 13'	76 20'	91 25'	110 39'



STAINLESS STEEL FOAM JET NOZZLE

- Great for fountains with fluctuating water level
- Not water level dependent

RETAIL FRIENDLY

Part #	MPT Inlet Size	Stocking Code	List Price	Spray Height				
				1' GPM Head	2' GPM Head	4' GPM Head	6' GPM Head	8' GPM Head
FJT10	1"	877996	\$119.99	13 2'	17 3'	22 5'	30 8'	34 22'



BRONZE AERATING NOZZLES

- Produces a narrow white water stream, swivel allows nozzle to tilt up to 15°
- Less water level dependent than Frothy (above) — unique design allows water level to fluctuate a few inches without affecting performance

Part #	Inlet Size	Stocking Code	List Price	Spray Height					
				2' GPM Head	4' GPM Head	6' GPM Head	8' GPM Head	12' GPM Head	16' GPM Head
AN1	1"	980460	\$123.79	8 5'	13 9'	15 11'	17 16'	—	—
AN2	2"	6246808	\$379.69	16 8'	23 9'	30 13'	40 20'	47 30'	55 37'



PVC SPRAY NOZZLES

- Lower cost option to bronze nozzles with attractive white water columns
- Not water level dependent, has NPT threaded inlets

Part #	Inlet Size	Stocking Code	List Price	Spray Height				
				4' GPM Head	6' GPM Head	8' GPM Head	12' GPM Head	16' GPM Head
SCFRN	2"	344268	\$68.09	35 8'	40 10'	45 13'	55 16'	65 23'
SCFRN3	3"	564802	\$99.69	63 8'	81 10'	91 13'	105 16'	128 25'



SMOOTH JET NOZZLES

- Use in multiples to create spray rings, nozzles are adjustable up to 15° in or out
- Each nozzle creates a smooth, continuous stream of water
- Nozzles are most often used to create an arch of water towards the center of the fountain, the performance data below shows gpm needed for that
- **SJN37N** has $\frac{7}{16}$ " male threads, **SJN75N** has $\frac{3}{4}$ " female threads

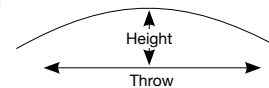

Performance Data for:

Part #	Stocking Code	List Price	4' Throw/	6' Throw/	8' Throw/	10' Throw/	12' Throw/
			25" Height	30" Height	36" Height	41" Height	48" Height
			GPM Head	GPM Head	GPM Head	GPM Head	GPM Head
SJN37N	322487	\$34.59	.5 5'	.75 6'	1 7'	1.5 9'	- -
SJN75N	639324	\$60.49	2.5 5'	3 6'	4 7'	4.5 9'	5 10'



Nozzles can also be used to shoot straight up, please see our web site www.easypropondproducts.com for performance data on vertical sprays.



BRONZE WATERBELL NOZZLES

- Classic formal spray pattern
- Not water level dependent

Part #	Inlet Size	Stocking Code	List Price	Flow Data For		
				2' Dia. GPM Head	3' Dia. GPM Head	4' Dia. GPM Head
WB10	1"	177547	\$119.29	6 5'	8 7'	10 9'
WB20	2"	6187652	\$288.69	10 5'	13 7'	16 9'



BRONZE MULTI-SPRAY NOZZLES

- Circular spray with hundreds of water droplets, an impressive display without a lot of sound
- Not water level dependent
- Use adequate screening on pump inlet to prevent debris from plugging nozzles

Part #	Inlet Size	Stocking Code	List Price	Flow Data For		
				2' Dia. GPM Head	3' Dia. GPM Head	4' Dia. GPM Head
MS10	1"	877995	\$119.99	5 3'	7 4'	10 5'



BRONZE FAN JET NOZZLES

- Arching spray pattern that is not water level dependent
- Use adequate screening on pump inlet to prevent debris from plugging nozzles

Part #	Inlet Size	Stocking Code	List Price	45° Spray Angle Info			
				2' GPM Head	3' GPM Head	4' GPM Head	5' GPM Head
FJ1	1"	296651	\$148.69	10 4'	13 5'	16 8'	20 10'



BRONZE THREE TIER NOZZLE

- Nozzle is not water level dependent
- Use adequate screening on pump inlet to prevent debris from plugging nozzles

Part #	Threaded Inlet Size	Stocking Code	List Price	Performance Data for:			
				6' High/ 18' Diameter GPM Head	8' High/ 24' Diameter GPM Head	10' High 24' Diameter GPM Head	12' High 24' Diameter GPM Head
3TN2	1 1/2"	8342415	\$526.79	38 12'	43 14'	50 16'	55 19'



For more fountain options check out our Lake and Pond Catalog!
Go to easypropondproducts.com/catalog-request
or call 800-448-3873 to get your copy today!

EasyPro offers a variety of tanks and tank systems for both educational and aquaculture applications. Tanks are lightweight, inexpensive, freshwater or saltwater compatible and have a long life expectancy. These one piece tanks do not have factory installed drains, use bulkhead fittings on page 107 for water tight drain connections. Tanks are shipped FOB Minnesota, allow 10 to 14 days delivery time. All tanks on this page are available in black, green, blue or natural. Tanks ship blue if not specified.

ROUND, FLAT BOTTOM TANKS



We've sold these tanks all over the United States and in Canada for a wide variety of applications including aquaculture production, koi display tanks, filtration tanks, holding tanks and many other uses. Tanks are nestable for reduced shipping cost.

Part #	Diameter	Depth	Capacity	Stocking Code	List Price
PT3931*	39"	31"	110 gallon	3195758	\$244.69
PT4822	48"	22"	125 gallon	6220559	\$275.69
PT4825*	48"	25"	150 gallon	7220554	\$275.69
PT5228*	52"	28"	180 gallon	4245270	\$306.59
PT5430	54"	30"	200 gallon	1318399	\$397.99
PT6530	65"	30"	300 gallon	6391517	\$489.39
PT8030	80"	30"	500 gallon	5489433	\$611.79
PT9038	90"	38"	800 gallon	2610236	\$762.79
PT9650	96"	50"	1200 gallon	1952554	\$1190.69

*PT3931, 4825 and 5228 have a sump pit in the floor of the tank.

SEMI-SQUARE TANKS



Provide the most volume of water in a gross area. Neatly contoured for self cleaning. These nestable tanks also feature a sloped bottom for total tank drainage. Tanks do need a support stand.

Ideal for koi display tanks! Stands are available for tanks - please inquire!

Part #	Dimensions	Capacity	Stocking Code	List Price
PT2618	26" x 26" x 18"	50 gallon	4122630	\$153.29
PT3127	31" x 31" x 27"	110 gallon	3220551	\$275.69
PT4222	42" x 42" x 22"	180 gallon	6268877	\$336.09
PT6228	62" x 62" x 28"	450 gallon	7587518	\$734.39

CONE BOTTOM TANKS

Cone bottom tanks are excellent for filtration tanks as well as aquaculture production, they require a stand for support. Tanks are light blue in color and are nestable for shipping. Cone bottom tanks provide the best self cleaning action, a 20° cone bottom forces solids to the bottom center of the tank allowing for continuous cleaning action. Tank depth listed below does not include cone, overall depth is tank and cone bottom.

Stands are available for tanks - please inquire!

Part #	Diameter	Tank Depth	Overall Depth	Tank Capacity	Stocking Code	List Price
CB6028	60"	28"	38"	250 gallon	3245271	\$306.59
CB7530	75"	30"	43"	450 gallon	8465756	\$582.19
CB8530	85"	30"	44"	650 gallon	5489431	\$611.79
CB9636	96"	36"	53"	950 gallon	4807752	\$1009.69
CB10260	102"	60"	70"	1500 gallon	5978796	\$1223.49



Fish Systems

Ideal for displaying koi and goldfish in retail settings, and for small scale aquaculture production in a classroom or business setting. The key to any system is the filtration, all our systems use EasyPro bead filters which provide excellent mechanical and biological filtration. The quality filtration is why the fish carrying capacity of these systems are much higher than other similar sized systems. Garden centers, retailers and pond stores all use these systems with great success.



THE FISH SYSTEM 1

A single tank set up that requires less than 6' x 8' of space. Commonly used in retail stores and pond shops, this system is also found in many school classrooms studying aquaculture.

System Includes:

One PT6530 300 gallon fish tank 65" diameter x 30" deep; One EX4500 energy efficient, continuous duty pump; One PBF15 EasyPro bead filter, rated for up to 60 pounds of fish and all necessary fittings, valves, unions, pipe, etc.



THE FISH SYSTEM 2

A dual tank version of the system above. Dual 300 gallon tanks allow you to keep different species or different sizes of fish in the same system. Over the years this system has proven to be the best selling system due to its increased capacity with minimal additional cost to a single tank setup.

System Includes:

Two PT6530 300 gallon fish tanks; One EX4500 energy efficient, continuous duty pump; One PBF35 EasyPro bead filter, rated for up to 150 pounds of fish and all necessary fittings, valves, unions, pipe, etc.

Part #	Description	Stocking Code	List Price
RCS2	Complete Fish System, 1 Tank	41206706	\$1683.49
RCS3	Complete Fish System, 2 Tanks	71898422	\$2634.29

Tanks ship direct, via truck, from factory - other components ship from EasyPro

HOW TO DESIGN AND BUILD A WATER FEATURE

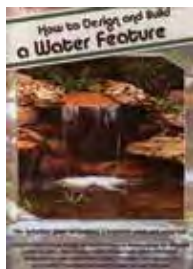

- Over two hours of information
- Bill Meakin, owner of Over The Garden Wall - a high end pond builder in Georgia - has created this very informative DVD aimed at educating contractors and home owners alike on topics like pond location, design ideas, step by step construction techniques, how to choose plants for aquatics and for around the pond.

Part #	Description	Stocking Code	List Price
DVD1	Design/Build Water Features	325008	\$46.69

PROMO DVD

- Professionally filmed and narrated, is designed to excite new pond owners on the features and benefits of the EasyPro pond system
- Many different ponds and waterfalls are featured on this ten minute DVD
- From small inexpensive ponds to our largest project ever, a \$1,000,000.00 water feature!
- Intended as a promotional DVD to excite potential customers
- DVD won first place at the National Video Convention for best promotional piece, call for special pricing on large quantities



Part #	Description	Stocking Code	List Price
EPDVD	Promotional DVD	47277	\$11.19

See what's new at easypropondproducts.com

We are continuously revising, updating and perfecting our website to create the most helpful resource for our users. Check out some of the great tools we've created to help you imagine, create and enjoy your pond or water feature.

A. New Products for 2013

We are always expanding our lineup of quality pond equipment, learn about the latest additions here.

B. Resources

Find helpful videos, product manuals, FAQs and more

C. News

Keep an eye on the latest from EasyPro. We frequently update our news with new product releases, what's next in our industry and other helpful resources.

D. Search Function

Search our catalog by model number, keyword or specification. Look for special "search keywords" in our ads for online promotions.

E. Products

Browse through our expansive product catalog to find equipment solutions.

F. Gallery

Visualize your next water feature project here or watch videos of products in action on our YouTube channel.



JUST-A-FALLS

- Covers all the aspects of building a waterfall without a pond
- Over one hour of valuable information to educate home owners and contractors on the ins and outs of building these popular features



Part #	Description	Stocking Code	List Price
DVD2	Just-A-Falls	225002	\$46.69

TRAINING, SEMINAR & SHOW DVDS

- We are pleased to offer six information packed Power Point presentations - all on one dvd!
- Great for sales training, seminar presentations, shows, etc. - each seminar is full of rich photo examples
- Includes self looping program for in-store presentations



Topics Included

Water Features with EasyPro

Provides all the formulas and the step by step processes of planning, quoting and installation of any project

Bringing Ponds to Life with Plants & Fish

Full of techniques and photo examples of how to make your projects come to life starting the day you finish the project

Effective Pond Filtration

Filtration tips and answers to the most frequent filtration challenges we get calls on, reduce expensive call backs by learning how to fine tune the filtration

Pond & Ornamental Fish Care

Focuses on maintaining "pond balance" naturally, water treatments and fish care — symptom, cause, solution based with photo examples for each topic

Selecting the Proper Pump

How to select the proper pump for any project

Show Booth Presentation

Self looping presentation on EasyPro Pond Products

Part #	Description	Stocking Code	List Price
PCD4	Power Point CD	25796	\$9.99



Visit our website to view and download these promotional pieces, manuals and MSDS sheets:
www.easyprompondproducts.com/resources



PRO-SERIES POND KIT BROCHURE

This four page handout is a great sales tool for selling Pro-Series skimmers, filters and pond kits. #EPH



MINI POND KITS & ECO-SERIES KITS BROCHURE

One side features the mini pond kits. The opposite side has the Eco-Series pond and Just-A-Falls kits. #MPF



POND & FISH CARE BROCHURE

A great promotional piece covering the benefits of our water treatment line as well as fish foods and the Pond Monsta cleaning system. The trifold design is easy to display, folds open to 11" x 17". Inside has customer friendly info on each water treatment including dosage rate and when to apply. #PCF



PRO-SERIES JUST-A-FALLS BROCHURE

Facts and photos on our popular "Just-A-Falls" water features. Includes information on pump vaults and complete kits. #JAFF



ECO-SERIES BROCHURE

This four page, full color piece features Eco-Series products. #ESF



LIGHTING BROCHURE

Focused on the particulars of our EasyPro lighting options. Lists advantages and components for each light. #ELF



VIANTI FALLS BROCHURE

This handout presents features and styles of the Vianti Falls waterfall kits and spillways. #VFF



SUBMERSIBLE PUMP BROCHURE

These full color handouts are full of information and pictures on our submersible pumps. #ESPF



SPILLWAY BROCHURE

This full color handout has all the details on our EasyPro spillways. #EWF



AERATION SYSTEMS BROCHURE

This full color handout highlights the benefits of aeration. Aeration kit information included. #KPAF



EXTERNAL PUMP BROCHURE

These full color handouts are full of information and pictures on our external pumps. #EXF



MULTI-VENT UNDERLINER BROCHURE

This is a full color brochure explaining how this system can provide venting, drainage and leak detection. #MVF



FOUNTAIN STATUARY AND BASINS BROCHURE

This brochure shows available statuary and information on Eco-Series and Pro-Series basins. #FBF



RAIN WATER CONTAINMENT BROCHURE

Provides detailed information on the standard systems as well as custom kits. #RWF

Part #	Package Qty.	Stocking Code	List Price
EPH	50	19503	\$18.79
MPF	50	67501	\$14.09
PCF	50	77502	\$14.09
JAFF	50	57505	\$14.09
ESF	50	29507	\$18.79
VFF	50	37500	\$14.09
ESPF	50	49504	\$18.79

Part #	Package Qty.	Stocking Code	List Price
ELF	50	37504	\$14.09
KPAF	50	97508	\$14.09
EXF	50	57507	\$14.09
EWF	50	67506	\$14.09
FBF	50	89502	\$18.79
RWF	50	17509	\$14.09
MVF	50	37506	\$14.09
TDF	50	29500	\$18.79



TRANQUIL DÉCOR BROCHURE

A brochure covering the full line of Tranquil Décor products from real basalt columns to decorative vases. #TDF

A

Accessories, Pond Liner..... 51
 Activated Carbon 70
 Aeration Systems, Ponds..... 58, 59
 Air Diffusers 61
 Algacide..... 71-73
 All-in-One Filter 78
 All-in-One Pond Package..... 67
 Aluminum Termination Bar 51
 Animal Deterrents 57
 Aphid Control 70
 AquaFalls Filters & Termination Strips.....9
 AquaFalls Replacement Parts & Rock Grate.. 10
 Aquasis Pumps 85
 Aquatic Plant Fertilizer..... 70
 AquaUltra Violet Ultima II Filters..... 82
 AquaUltra Violet UV Lights & Parts ... 82
 Artesian Pro External Pumps 100
 Auto Fill Valves 38
 Axiom Skimmer/Filter Combo 5

B

Bacteria 68, 72
 Bacti-Twist Filter Media 76
 Bags, Fish Shipping 55
 Bags, Media 55
 Ball Valves 106
 Bander Tool 55
 Barley Extract 68, 72
 Barley Straw Bales 68
 Barley Straw Pellets 72
 Basalts..... 30, 36
 Basins..... 28, 29
 Bead Filters 79
 Berkely External Pumps 101
 Bio-Balls Filter Media 76
 Bio-Blox Filter Media 76
 Biological Filter Media 76
 Biological Filters 9
 Biological Pre-filter 75
 Bio-Steps Filter..... 77
 Black Gun Foam..... 37
 Black PVC Fittings..... 105
 Black Waterfall Foam 37
 Blue Pond Dye..... 69
 Bottom Drains & Kits 53
 Boulders 61
 Bronze Fountain Nozzles..... 112, 113
 Bubbling Columns..... 30
 Bubbling Rock..... 36
 Bulbs, Lights..... 42, 44, 45
 Bulkhead Fittings..... 107

C

Cam Lock Fittings 109
 Carbon..... 70
 Carry Submersible Pumps 92
 Centrifugal Pumps..... 101
 Check Valve Assemblies 39
 Check Valves, PVC..... 106, 107
 Clarifier, Water 69
 Cleaner, Gun Foam..... 37
 Columns, Bubbling..... 30
 Commercial Grade UV Sterilizers 80, 82

Compressors 60
 Containment Kits, Rainwater..... 16
 Couplers, Rubber 109
 Crystal Clear..... 70

D

Debris Nets, Skimmers..... 11
 Defoamer 69
 De-icer/Heater, Pond..... 58, 62
 Deterrents, Animal 57
 Diffusers, Air 61
 Direct Drive Pumps 84
 Disease Treatments 73, 74
 Dye, Pond..... 69

E

EasyWeave Pond Liner..... 52
 Ecofix, Water Clarifier..... 74
 Expandable Spillways 23
 Extension Tubes 7
 Extension, Pump Vault 20
 External Pond Skimmer..... 7
 External Pump Intake Filters 96
 External Pumps 97, 98

F

F&Q Submersible Pump..... 90
 Fertilizer, Aquatic Plant..... 70
 Fiber Optic Lighting..... 44, 45
 Fill Box, Water 38
 Fill Valves, Water 38
 Filter Brush Rack, Skimmers..... 11
 Filter Brushes 11, 77
 Filter Floss Bio-Media 76
 Filter Mats, Skimmer 11
 Filter Media..... 75, 77
 Filter Pads, Waterfall 10
 Filter Stand 96
 Filter, Pump Intake..... 96
 Filters, Pressurized..... 78, 79
 Filters, Waterfalls 5, 8, 9
 Fire & Water Kit..... 24
 Firestone Pond Liner 50
 Firestone Quick Prime 51
 Fish Display Systems 114
 Fish Food..... 64, 65
 Fish Nets 55
 Fish Shipping Bags 55
 Fish Treatments 73, 74
 Fittings, Bulkhead..... 107
 Fittings, Cam Lock 109
 Fittings, Nylon Tubing..... 108
 Flanges, Schedule 108
 Flexible PVC Pipe 102
 Floating Fountain w/LED Lights 54
 Foam Gun..... 37
 Foam, Black Gun..... 37
 Foam, Black Waterfall 37
 Food, Fish..... 64, 65
 Formal Fountain Nozzles..... 111-113
 Formal Water Features 24
 Formal Waterfall Kits 24
 Fountain Basins 28, 29
 Fountain Cleaner 70
 Fountain Kits, Statuary..... 32-34
 Fountain Nozzle Set 85

Fountain Nozzles 112, 113
 Fountain, Floating w/LED Lights 54
 Fountains, Statuary 32, 36

G

Game Fish Food 64
 Gate Valves..... 106
 Goulds External Pumps..... 101
 Goulds Submersible Pump 91
 Green Clean Algacide..... 71
 Gun Foam Cleaner 37
 Gun, Foam..... 37

H

High Strength Reservoir Cubes..... 21
 Horizontal Submersible Pump..... 90
 Hose Clamps, Stainless Steel 61
 Hy-Drive Pump 84

I

Installation Kit, Waterfall 37
 Intake Filter Stand 96
 Intake Filters 96
 Integra Liner 49

J

Japanese Lanterns 36
 Just-A-Falls Kits 25-27
 Just-A-Falls Outlet Assemblies 39

K

Kink-Free Tubing 103
 Koi Food..... 64, 65
 Koi Pond Kits..... 12-15

L

Lanterns, Japanese..... 36
 LED Light Strips 41
 LED Underwater Lights 40, 41, 43
 Lids, Skimmers..... 11
 Lights..... 40, 41, 43
 Lights, UV Clarifier/Sterilizer..... 80-82
 Lap Sealant 51
 Liner Air Vent 47
 Liner, Accessories 49-52
 Liner..... 49, 50, 52
 Liner, Pond Seal 48
 Liner, Underlayment 48
 Liner, Water Block 51
 Low Voltage Transformers..... 46

M

Mag Drive Pumps..... 84, 86
 Matala Submersible Pump 90
 Matala UV Replacement Parts 80
 Matala Biological Pre-filter 75
 Matala Bio-Steps Filter..... 77
 Matala Filter Media..... 77
 Matala UV Clarifiers..... 80
 Matala Pond Vacuum II 56
 Media Bags 55
 Melafix, Fish Treatment 74
 Mesh Bags, AquaFalls 11, 55
 Meter, Salinity 66
 Microbe-Lift 72
 Multi-Vent Underliner System..... 47

N

Nets, Skimmers 11
 Netting, Pond 63
 Nozzle Set, Fountain 85

Nozzles, Fountain 112, 113
 Nozzles, PVC..... 112
 Nylon Tubing Fittings..... 108

O
 Outlet Assemblies 39

P
 pH Down/pH Up..... 69
 Ph Pen..... 66
 Ph Test Kit 66
 Pimafix, Fish Treatment..... 74
 Pipe Boot, Pond Liner 51
 Plant Fertilizer..... 70
 Polished Rock, Black..... 35
 Pond Aeration Systems..... 58, 59
 Pond Bacteria..... 68
 PondCare 74
 Pond Cleaning System..... 56
 Pond Cover Netting..... 63
 Pond Defoamer 69
 Pond Dye..... 69
 Pond Filter, Submersible 8
 Pond Heater/De-icer 58, 62
 Pond Kit Check Valve Assemblies..... 39
 Pond Kits..... 12-15
 Pond Liner & Accessories 49-52
 Pond Nets, Telescoping 55
 Pond Salt..... 70
 Pond Skimmers..... 4-6
 Pond Test Kits 66
 Pond Thermometer 66
 Pond Vacuums 56
 Pond Shield Pond-Armor Sealant 47
 Pondless Waterfall Kits..... 25-27
 Pondmaster 84
 Pondmaster Deicer..... 58, 62
 Pondmaster Submersible Pumps 84
 Pond Monster II..... 56
 PondSeal 48
 Pre-filter, Biological 75
 Pressurized Filters..... 78
 Primer/Glue, PVC 104
 Professional Foam Gun 37
 Promotional Materials 115, 116
 Pump Check Valve Assemblies..... 39
 Pump Cleanout Package..... 87
 Pump Outlet Assemblies..... 39
 Pump Pro-Tectors 54
 Pump Screen..... 93, 96
 Pump Shut-Off Switches..... 95
 Pump Screen, Submersible..... 54, 96
 Pump Vaults & Extension 20
 Pump, Self-Priming 97, 99, 100
 Pump, Solids Handling..... 87
 Pumps, Centrifugal..... 101
 Pumps, External 97, 98
 Pumps, Submersible 84-92
 PVC Check Valves..... 107
 PVC Fittings 104-107
 PVC Fittings, Black..... 105
 PVC Flexible Pipe..... 102
 PVC Primer/Glue 104
 PVC Specialty Fittings..... 105
 PVC Unions 105

Q
 Quick Prime..... 51
 Quick Scrubber Tool, Liner..... 51

R
 Rainwater Containment Kits..... 16
 Replacement Filter Pads, Waterfalls ...10
 Replacement Parts, Underwater Lights ...42
 Replacement Parts, AquaFalls 10
 Replacement Parts, Eco-Series Waterfalls...10
 Replacement Parts, Skimmers..... 11
 Reservoir Cubes..... 21
 Rock & Waterfall Cleaner..... 68
 Rock Grate, AquaFalls..... 10
 Rock Lights 43
 Rock, Polished Black 35
 Rubber Couplers 109
 Rubber Pond Liner 49, 50

S
 Sales Flyers 116
 Salinity Meter..... 66
 Salt, Pond..... 70
 Scarecrow Sprinkler 57
 Screens/Protectors Submersible Pumps..... 54, 96
 Sealant, Pond-Armor..... 47
 Sealant, Ponds & Fountains 47
 Sealant, Silicone..... 37
 Seam Roller, Liner 51
 Seam Tape, Liner..... 51, 52
 Self-Priming External Pump 97, 99
 Self-Weighted Tubing 61
 Silicone Sealant..... 37
 Skimmer Check Valve Assemblies 39
 Skimmer Replacement Parts..... 11
 Skimmer UV Light 7
 Skimmer Weir 11
 Skimmers 4-6
 Solar Lighting 42
 Solids Filter Media..... 75
 Solids Handling Pump..... 87
 Specialty PVC Fittings..... 18
 Spillways, Pro Series..... 23
 Spillways, Eco-Series..... 22
 Spillways, Expandable 23
 Spillways, Universal Waterfall Diffuser ..17
 Spillways, Vianti Falls 18
 Splitter, Statuary..... 36
 Spring/Summer Cleaner..... 73
 Stainless Steel Spillway..... 18
 Stainless Steel UV 81
 Stainless Submersible Pumps..... 88
 Stand, Intake Filter 96
 Standard Reservoir Cubes 21
 Statuary Basins 28, 29
 Statuary Fountain Kits 36
 Statuary Fountains 31-36
 Statuary Splitters..... 36
 Strainer Basket, External Pump 98
 Strainers, Suction 105
 Stress Coat, Fish Treatment 74
 Submersible Filter w/UV..... 78
 Submersible Pump Protector..... 54
 Submersible Pump Screen..... 93, 96

Submersible Pumps 84-92
 Suction Strainers 105

T
 Tabletop Fountain Pumps 87
 Tanks 114
 Telescoping Pond Net 55
 Test Kits..... 66
 Thermometer, Pond..... 66
 Thermo-Pond 62
 Timer w/photo eye 46
 Tool, Bander 55
 Tranquil Décor 30-35
 Transformer, Low Voltage..... 46
 Trash Pump, Submersible 87
 Tsurumi Pump 90
 Tubing, Kink-Free 103
 Tubing, PVC..... 102
 Tubing, Self-Weighted 61
 Tubing, Vinyl 103

U
 Ultima II Filters..... 82
 Ultimate Tube Media 76
 Ultra Sonic Repeller..... 57
 Underlayment, Liner 48
 Underwater Lighting 40, 41, 43
 Union Check Valve 106
 Unions, PVC 105
 Universal Waterfall Diffuser 17
 UV Clarifier/Sterilizer 80-82
 UV Light, Skimmer 7
 UV Lights..... 80-82
 UV Replacement Parts 7, 78, 80-82
 UV Sterilizers, Commercial..... 80, 82

V
 Vacuum, Pond..... 56
 Valve Box..... 109
 Valves, PVC 107, 109
 Vaults, Pump 20
 Venting System for Liner 47
 Vianti Falls Kits 19
 Vianti Falls Spillway 18
 Vinyl Tubing 103

W
 Water Block, Liner..... 51
 Water Clarifier..... 69, 80
 Water Conditioner 69, 74
 Water Fill Box 38
 Water Fill Valves 38
 Water Test Strips 66
 Water Testing..... 66
 Water Treatment Center 67
 Water Treatments 68
 Waterfall Diffuser 17
 Waterfall Filters..... 8, 9
 Waterfall Installation Kit..... 37
 Waterfall Kits, Formal 24
 Waterfall Kits, Pondless..... 25-27
 Waterfall Pumps 93
 Waterfall Replacement Filters..... 8, 9
 Waterfall Replacement Parts..... 10
 Waterfall Spillway 18, 22, 23
 Weir, Skimmers..... 11

Technical Assistance — 2013 marks our 43rd year in the aquatics business. We feel it is better to spend time helping you properly select products now rather than spend time with you later helping to solve the problems (and expense) of incorrect products! Please feel free to contact us for free design assistance on pond, waterfall, aeration, filtration, etc. Whenever possible please fax a diagram of your layout to provide us a visual reference.

Large Orders — If you are in need of a large quantity of an item (or items), please provide us a list of items and quantity needed so we can quote you prices.

Ordering

Place orders in any of the following ways:

Telephone - Orders by phone can be placed at 231-834-7720 or toll free at 800-448-3873;

Monday to Friday; 8am to 5pm Eastern time.

Fax - Orders by fax can be sent to 231-834-5537, for your convenience there is a faxable form on page 117

Email - Orders by email can be placed at orders@easypropondproducts.com. This email is for orders only. For special project quote requests (ponds, Just-A-Falls, fountains, aeration, etc.) can be placed at quotes@easypropondproducts.com. For other questions, quotes or other services please call 800-448-3873.

Shipping Information

Items Less Than 150 Pounds — These items usually ship UPS. Some items are shipped without a box (i.e. flex pipe, kink-free tubing, etc.) - UPS charges an extra \$8.50 for each item. Large items shipping UPS are charged based on dimension and weight (i.e. filter material, pond kits, skimmers, aquafalls and boulders).

Large and/or Heavy items are shipped motor freight — Last year we shipped more than 1.6 million pounds of freight over truck lines. Because of our large volume we have negotiated large discounts with our truck lines from their standard rates. This makes us very competitive when shipping large orders. Motor freight companies charge a residential fee when delivering to a residence.

Damaged Shipments — Please inspect your shipment before signing for it! Once you sign for it, the carrier will not be liable for shortages or damage. You can refuse a damaged shipment or accept it with clear notification of damage on the bill of lading. Please call us immediately if a damaged order is refused so we can accept it back from the carrier and reship your order.

Returns

All returns must have an RA# (Return Authorization Number). This lets us know what is coming back and what to do with it (i.e. credit your account, replace product, etc.). A 10% restock fee will apply to returns unless it is our shipment error. Packages sent to us without an RA# written on them will be refused! All products, including warranty items, must be returned to us shipping prepaid. We will pay the shipping charges on warranty items back to you, but not from you to us. Product over 90 days old is not returnable for credit. Special orders, cut liner and used items are not returnable.

Payment Options

Credit Cards — We accept VISA, MasterCard and Discover

Money Orders/Checks — Money orders or business checks are accepted as payment.

Net 30 Account — Companies wishing to set up an account with us need to fill out our credit application. Schools, institutions and governmental agencies are pre-approved with use of a purchase order number. Interest will accrue on all invoices over 30 days. No orders will be shipped to customers with invoices over 60 days old until account is brought current.

Hours

Business Hours — Monday through Friday, 8:00 a.m. to 5:00 p.m. EST; **Sales, design, shipping and office closed Saturdays**

We will be closed for the 2013 holidays on Saturday, May 25 & Monday, May 27; Thursday, July 4; Saturday, August 31 & Monday, September 2; Thursday, November 28 & Friday, November 29; Tuesday, December 24 through Wednesday, January 1, 2014.

Warranty

EasyPro honors all manufacturer's warranties. Each manufacturer has their own warranty procedure. Some manufacturers allow us to determine warranty for them, while others handle their own warranty. Submersible pumps that have been run out of water, have been altered or have cuts to the power cord will not be covered by warranty. Also, any product not used for its intended purpose, altered, damaged, improperly maintained or neglected will not be covered. Submersible pumps cannot be taken apart, this voids warranty. Shipping costs to us (or to the manufacturer) are not covered by warranty, please insure package when shipping back to us. If product is covered by warranty we will pay shipping costs to ship new/repaired item back to you. Product returned to us for warranty that is deemed in working condition will be shipped back to you at your expense. Be sure your electrical supply is proper before returning pumps to us — each year we get numerous returns that are in good working order only to find the problem was in the electrical supply! A bench fee of \$20.00 will be charged for each pump returned to us that is not broken. Each year we test hundreds of pumps, many of which are fine. This fee covers time and materials used in testing pumps that are in good working order.

**A policy of continuous improvement is our goal,
therefore products may change from these shown.**

All prices subject to change without notice. We make every effort to maintain printed prices however, due to circumstances out of our control they may change.



Porous Pave

PERMEABLE • DURABLE • FLEXIBLE

Looking to generate new business revenue?

Permeable surfacing is one of the hottest buzz words in the market right now. EasyPro's affiliate company, Porous Pave Inc., offers one of the easiest to install, highest porosity surfacing materials anywhere in the U.S. and we are seeking certified installers.

This pour-in-place material is ideal for:

- Patios
- Sidewalks
- Paths & trailways
- Tree surrounds
- Parking lots
- Driveways
- Pool surrounds
- Playgrounds



Commercial • Residential • Municipal

Increase your profit margin over paver installation with Porous Pave

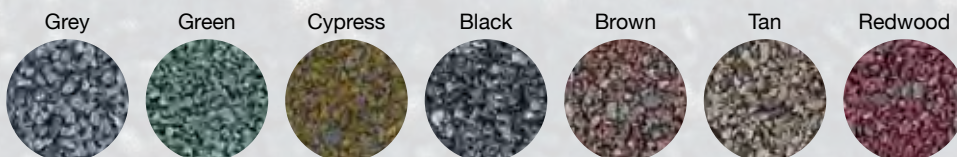

For more information call Porous Pave toll free at 888-448-3873

www.porouspaveinc.com • sales@porouspaveinc.com



4385 East 110th
Grant, MI 49327

231-834-7720
800-448-3873
Fax: 231-834-5537

info@easypropondproducts.com
www.easypropondproducts.com

PRSR STD MAIL
US POSTAGE
PAID
GRANT, MI
PERMIT NO. 5

Current Resident or

Issued January 2013

Catalog #43W

Two Specialized Catalogs for 2013!



EasyPro prides itself on offering the largest selection of products. Whether a small water feature or a large lake, we have products for nearly every application.

As our product line continues to grow year after year, it has become harder to contain it all in one catalog.

We Offer Two Separate Catalogs

- **The Pond and Water Feature** catalog contains products and information on ornamental ponds and water features
- **The Lake & Pond Management** catalog contains all of our water treatments, fountains, aeration systems and aquaculture supplies

Please contact us via phone or website to view or request copies of our catalogs!

